

SAIT

***When Quality, Service,
and Dependability Count!***



2016 - 2017

GRINDING WHEELS - PG. 13



Bench Wheels

Aluminum Oxide & Green Silicon Carbide Pg 33

Cones, Plugs & Mounted Points

Type 16, 17, 18 Pg 25
Type A, B, W 24

Contaminant-Free Wheels

XA24Q (1/4") Pg 16
XA24Q (1/8") 45

Cup Stones

Type 11 Pg 22-23

Exclusive Super-Lock™ Hub

Features Pg 12

Flexible Grinding/Blending

Type 29 Challenger Wheels Pg 21
Cotton Fiber 30-31

Grinding Wheels (1/4" Thick)

Introduction Pg 13
Type 27 14-18
Type 28 19-20

Hand and Floor Rubs

Plain, Fluted, Handle, Scored Pg 32

Pipeline Wheels (1/8" Thick)

Introduction Pg 27
1/8" Wheels 28-29

WIRE BRUSHES - PG. 131

Introduction Pg 131-132
Bench Wire Wheels 133
Cup Brushes (Small & Large) 133-134
Joint and End Brushes 137
Knot & Crimped Wire Wheels 135-136
Nylon Brushes 139
Pipeline Brushes 136
Scratch, Metal Chip, Acid, & Paint Brushes 138

CUTTING WHEELS - PG. 34



.045" Cutting Wheels

Type 27 (Type 42) Pg 36-37
Type 1 (Type 41) 38-39
Type 1 Contaminant-Free 1/16" 38

.090" Cutting/Notching Wheels

Type 27 (Type 42) Pg 40
Type 1 (Type 41) 41

.095" Combo Wheels

Type 27 (Type 42) Pg 42
Cut, Notch, Deburr, & Light Grind

3/32" & 1/8" Cutting Wheels

Type 27 Pg 43-45

Chop & Stationary Saw Wheels

Chop Saw Pg 50-51
Stationary Saw 56-57

Contaminant-Free Wheels

XA46R (1/16" Cutting) Pg 38

Diamond

Diamond Pg 62-63

Metal-Cutting Carbide Blades

Introduction Pg 58-59
Carbide Blades 60-61

Portable Saw Cut-Off Wheels

Type 1 (4-1/2" - 8") Pg 48
Type 1 (12" - 16") 52-54

Street Saw Wheels

Street Saw Pg 55

Thin High Speed Cut-Off

.035", 1/16" & 1/8" Pg 46

CARBIDE BURS - PG. 140

Introduction Pg 140
Carbide Burs 141

COATED ABRASIVES - PG. 64



Belts

Introduction	Pg 83-85
Belt Specifications	86-87

Cloth Discs

Introduction	Pg 88
Aluminum Oxide	96-97
Zirconium	96-97

Fiber Discs

Introduction	Pg 77
Fiber Discs	78-82

Flap Discs

Introduction	Pg 68-69
High Density	72-73
Mini	76, 98
Non-Woven & Interleaf	75, 126
Regular Density	70-71, 74, 76
Trimmable & Plastic	71, 73-74

Flap Wheels

Small Diameter	Pg 101
Large Diameter	102
5/8-11 Threaded	102

Floor Sanding

Discs	Pg 116
Rolls	117
Saitscreen™	117
Sheets/Belts	115

Laminated Discs

SAIT-LOK™	Pg 98-100
SAIT-LOK-R™	98-100

Paper Discs

Introduction	Pg 88
Hook & Loop	93-95
PSA Disc Rolls	89-90
PSA Disc Individual	91-92, 95

Sheets

Introduction	Pg 103
Cloth	104
Fileboard	107
Paper	104-105
Saitscreen™/Drywall	106
Sanding Sponges	107

Shop Rolls

Industrial/Handy	Pg 108
Mini/Custom	109-110
Saitscreen™/Plumber	110

Specialties

Cartridge Rolls	Pg 112-113
Cross Pads	114
Spiral Bands	111
Square Pads	114

NON-WOVEN ABRASIVES - PG. 118

Belts	Pg 120	Hand Pads	Pg 119
Buffing Pads/Compounds	130	Interleaf (Wheels & Flap Discs)	125-126
Convolute Wheels	128	SAIT-Strip™ Products	129
Discs	121-122	Sand-Light™ Blending Discs	123
Flap Brushes	124	Sand-Light™ (Flap Discs)	126
Flap Wheels	125	Unitized Wheels/Type 27	127

ACCESSORIES / LITERATURE / DISPLAYS - PG. 142

CATALOG GUIDE

COLOR CODING SYSTEM

Our catalog has been color coded as follows for quick reference to these product groups.

GRINDING

- Type 27, 28 and 29 – general purpose to high performance
- Pipeline performs light grinding and cutting
- Cones, plugs, cup stones and mounted points also available

CUTTING

- Type 27 and Type 1 to cut metal, stainless or concrete
- Includes our patented .045 and .090
- Large diameter wheels available for general purpose to specialty
- Metal cutting blades and diamond wheels

COATED ABRASIVES

- Type 27 and 29 Flap Wheels – regular and high density
- Fiber disc offering – most comprehensive in the industry
- Belts available in most common sizes & new portable, narrow & wide belts
- Full line of laminated, paper and cloth discs along with sheets, floor products and specialty items

NON-WOVEN ABRASIVES

- Extensive product offering for a variety of applications
- Use as a final finishing step
- Hand pads, belts, discs, flap brushes and more

WIRE BRUSHES

- Various styles to cover a multitude of applications
- Bench wire wheels, large and small cup brushes
- Knot and crimp wire wheels along with Pipeline brushes

CARBIDE BURS

- Top quality tungsten in the most popular shapes and sizes
- Double cut or alternate cut available
- Packaged in individual capsules for storage and protection

ACCESSORIES

- Many items to complement and match our product offering
- Specifically engineered for our products

- Privately held company established in 1970.
- Relationship with SAIT, an Italian corporation founded in 1953, began as we first manufactured coated abrasive belts.
- By 1975, we had expanded our production to include bonded abrasives.
- Worldwide reputation for quality, consistency, and the highest levels of service.
- One of the largest and leading manufacturers of abrasive products in the world for both bonded and coated.
- Continually updating and investing in all aspects of our company – production, shipping and customer support.
- Only premium raw materials are used.
- Demand consistent manufacturing operations and have one of the most rigorous quality control testing procedures in the industry.
- ***EVERY order is a RUSH delivery!*** From phone order to truck in minutes!



TECHNICAL & REFERENCE MATERIAL

Bonded Abrasives Application Chart _____	10-11
Bonded Abrasives Introduction _____	6-9
Coated Abrasives Application Chart _____	66-67
Coated Abrasives Introduction _____	64-65
Flap Discs Introduction _____	68-69
Index by Product Description _____	154-155
Marking System _____	8
Metal-Cutting Carbide Blade Technical Data _____	59
Promotional Information and Displays _____	149-151
Products By Tool Index _____	153
Safety Information _____	152
Storage and Handling _____	8 & 65
Super-Lock™ Hub _____	12
Wheel Label Example _____	8

BONDED ABRASIVES

What is a Bonded Abrasive?

A resin bonded abrasive is a grinding or cutting tool composed of abrasive grains which are held tightly together by a bonding agent and typically reinforced with a woven material. Within the bonded abrasives category are grinding and cutting wheels, as well as “stones” in a variety of shapes and sizes.

Main Components of Resinoid Bonded Abrasives

Abrasive Grains

Abrasive grains, sometimes referred to as grit, are particles of man-made compounds. The chemical structure of the grains determines the physical properties such as the shape and sharpness of each particle along with its hardness and friability (the propensity to break down). Common grain types used in making bonded abrasives include:

- **A - Aluminum Oxide**
A tough blocky shaped grain used for cutting metals and other high tensile strength materials without excessive fracturing
- **C - Silicon Carbide**
A very hard and very sharp abrasive suited for non-metallic materials such as concrete
- **Z - Zirconium**
A very fine, dense crystalline grain which can be used for rugged stock removal
- **SG - Ceramic**
A unique ceramic aluminum oxide that is two or three times tougher than standard aluminum oxide

Bonding Agent

The bonding agent that holds the grains together determines the resistance of the wheel.

Reinforcement

The reinforcement material provides strength to operate the abrasive product at the marked maximum RPMs and to withstand lateral pressure that is applied during use. This critical element, unseen to the naked eye, determines the structural strength of the product.

Combining the Components

During the manufacturing process, these three components are combined to form an abrasive tool. The grains and bonding agents are measured, combined, and then pressed in an automated hydraulic press. The items are then cured in temperature controlled ovens.

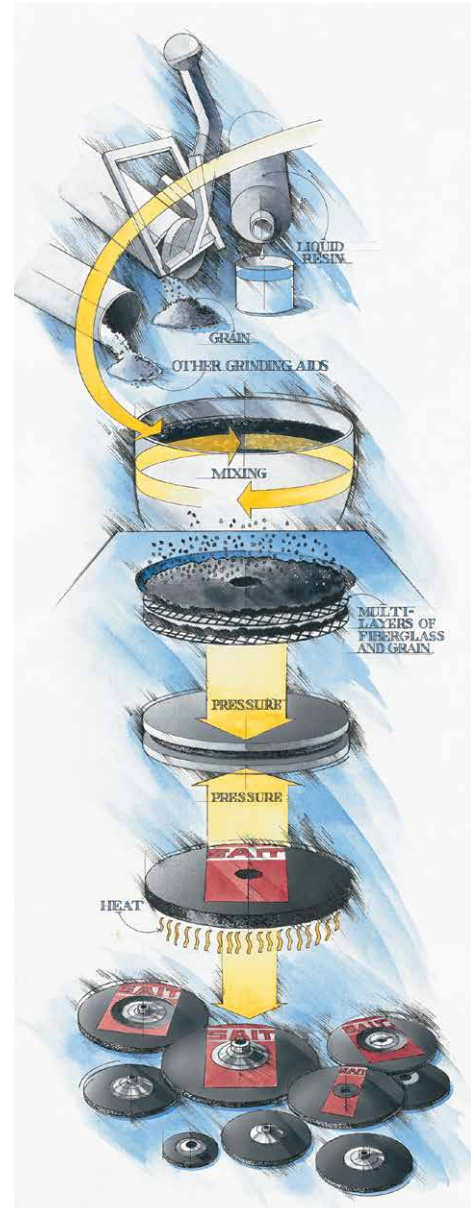



The

Difference

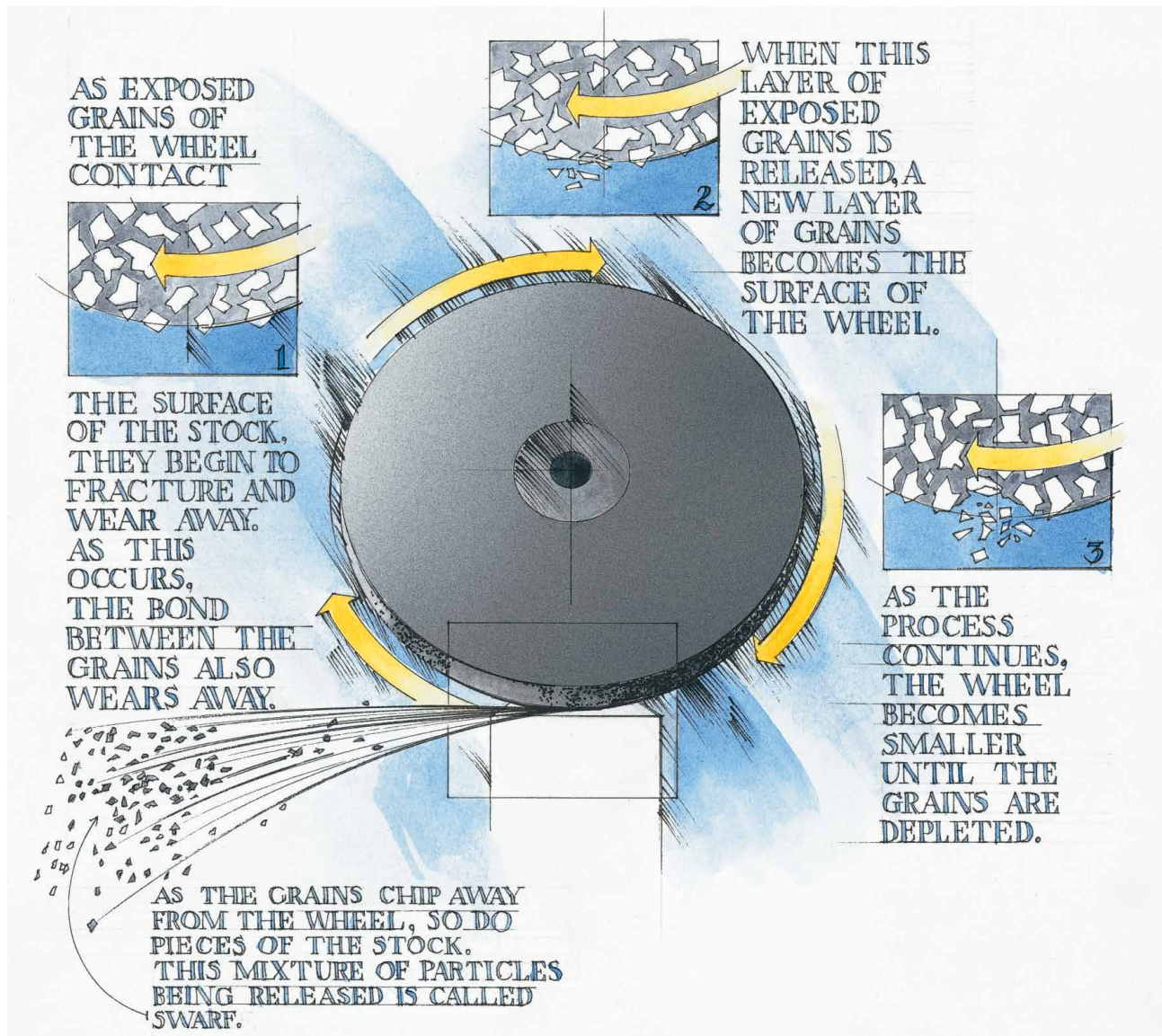

- Only uses first quality, premium grains that are made to our specifications
- Never uses inferior fillers or bonding agents
- Always uses first quality, heavy duty fiberglass to ensure your safety
- The manufacturing process, from start to finish, incorporates state-of-the-art equipment, quality control analysis and compliance, and rigorous product evaluation to ensure our customers receive the safest, most consistent and best performing wheels on the market

How a Wheel Works

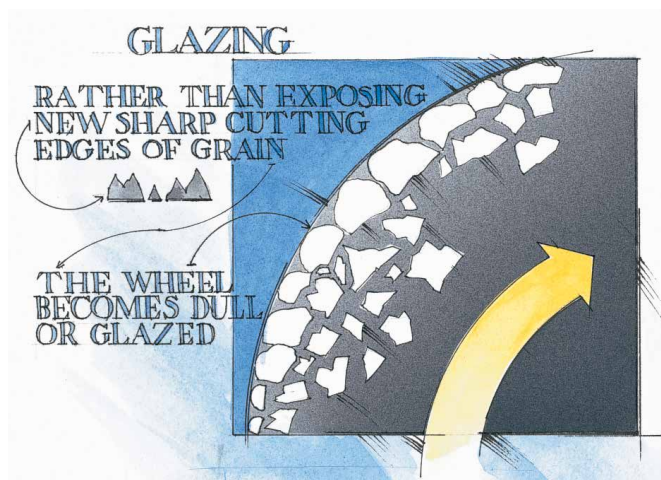

Common Occurrences With Grinding/Cutting Applications

As a wheel is grinding and/or cutting, some situations may occur with the application such as glazing or loading. Here is a description of each of these occurrences and some possible solutions.



Solutions to Glazing

- Dress the wheel for a temporary solution
- Use a softer bond and/or coarser grit wheel

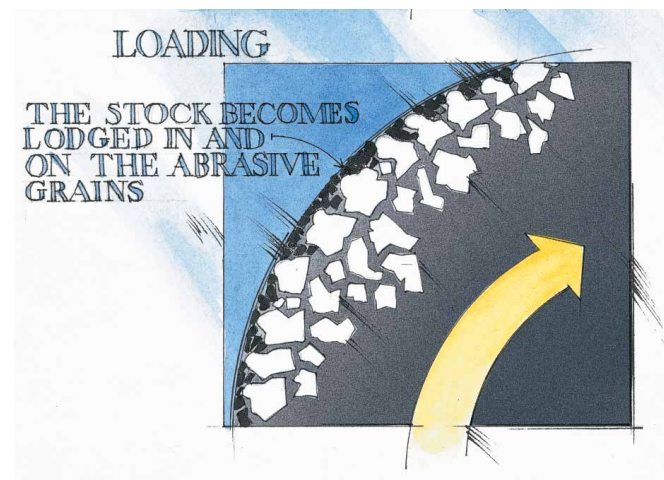

Solutions to Loading

- Dress the wheel for a temporary solution
- Use the correct wheel for the application

Sample of Wheel Label

Below is an example of a label that can be found on United Abrasives' wheels. We feel it is important to include as much information as possible on our labels so the end user has the pertinent information needed to operate the wheel. All of our labels are baked on the wheels during the manufacturing process so the label remains intact throughout the life of the wheel.



Wheel Label Color Coding:

METAL

STAINLESS

ALUMINUM

CONCRETE

Storage and Handling

All abrasive wheels are breakable and therefore care shall be exercised in handling and storage to prevent damage.

The following rules, which are based on experience, shall be observed:

- Handle wheel carefully to prevent dropping or bumping
- Do not roll wheels (hoop fashion)
- Use trucks or other suitable conveyances to provide support and protection in transporting all wheels which cannot be carried by hand
- Suitable racks, bins, drawers or boxes shall be provided to store the various types of wheels used
- Abrasive wheels should be stored in a dry area not subject to extreme temperature changes since some bonds may be affected by excessive humidity and temperature differentials
- Racks should be located as near as practical to the grinding location, but never where there is danger of damage from passing trucks, crane handling equipment or excessive vibration
- Please refer to the Safety Guide accompanying the product and on page 162 of this catalog.

Cutting & Grinding Application Chart

	Ferrous Metals *																
	Angle Iron	Bar Stock	Cast Iron / Ductile Pipe	Carbon Steel	Channel Iron	Decking	Heavy Rebar	High Tensile Steel	Iron Pipe	I-Beams / Rail Steel	Light Gauge Metals	Metal Studding	Metal Tubing	Stainless Steel	Steel	Thin Rebar	Welds
Type 27 General Purpose Grinding Wheels																	
A24N - Fast Grinding	•	•	•	•	•	•	•	•	•	•				•	•		•
A24R - Long Life	•	•		•	•	•	•		•	•					•		•
A24T - Edge Grinding	•	•			•				•		•	•			•		•
C24N - Concrete			•														
Type 27 Specialty Grinding Wheels																	
A46N - Aluminum																	
The Ultimate Grind™ - Premium Performance	•	•		•	•	•	•	•	•	•				•	•		•
Sait Z-tech™ - Zirconium High Performance	•	•		•	•	•	•	•	•	•				•	•		•
Saitech Ultimate Performance™ - Ceramic High Performance								•						•	•		•
Saitech Attacker® - Ceramic Fast Cutting			•					•						•	•		•
Stainless Contaminant Free														•			
Type 28 Grinding Wheels																	
A24N - Fast Grinding	•	•	•	•	•			•	•	•				•	•		•
A24R - Long Life	•	•		•	•		•		•	•					•		•
Saitech Ultimate Performance™ - Ceramic High Performance	•					•						•			•		•
Type 29 Flexible Grinding/Blending Wheels																	
Challenger II™ / Challenger 3	•	•			•	•		•	•	•	•		•	•	•		•
Type 27 Specialty Cutting & Light Grinding Wheels																	
Pipeline A24R - General Purpose	•	•			•	•			•	•	•	•	•	•	•	•	•
Sait Z-tech™ Pipeline / The Ultimate Pipeline™ - High Performance	•	•			•	•			•	•	•	•	•	•	•	•	•
Saitech™ Pipeline (S Pipe) - Ceramic	•	•		•			•	•	•	•				•	•		•
Type 27 (42) Cutting Wheels																	
A24R - Long Life	•	•		•	•	•	•		•	•				•	•		•
.095 - Cuts and Light Grinds	•	•		•	•	•	•		•	•	•	•	•	•	•		•
C24R - Concrete			•														
Type 27 (42) Specialty Cutting Wheels																	
Sait Z-tech™ - Zirconium High Performance	•	•		•	•	•	•	•	•	•				•	•		•
A46N .045 - Aluminum																	
Saitech .045 / The Ultimate Cut™ .045 - High Performance				•	•			•	•	•				•	•		•
Stainless Contaminant Free														•			
Type 1 Chop Saw Wheels - Cutting																	
EZ-Chop Attacker® - General Purpose	•	•			•		•		•		•	•			•	•	•
EZ-Chop® / Stud King® - Burr Free Finish											•	•			•	•	•
Saitech Steel Worker® / Z-tech™ - High Performance				•				•					•	•		•	•
Iron Worker™ - Structural Metal Applications	•	•			•		•		•						•	•	•
Non-ferrous Metals - Aluminum																	
Type 1 (41) High Speed Cut-off Wheels																	
A24R - General Purpose / Durability	•	•		•	•		•		•	•	•				•	•	•
SAIT-Pro - Economical Choice	•	•		•	•	•		•	•	•	•	•	•	•	•	•	•
A60S .045" - General Purpose				•	•			•			•			•	•		•
Saitech™ .045 / Z-tech™ .045 / The Ultimate Cut™ .045 - High Performance				•	•			•	•	•				•	•		•
C24R - Concrete			•														
Type 1 Portable Saw Cut-off Wheels																	
Brute™ - Thin Metal						•					•	•	•				
Hobo® - Railroad - rail steel	•	•			•		•		•	•							
Ductile™ - Ductile Pipe			•						•								
Big M.A.C.™ - Masonry, Asphalt, Concrete																	
Type 1 Cut-off Wheels for Street Saws																	
C16 - Green concrete, asphalt																	
C24R - Concrete																	
Street Walker™ - Hot pressed - fast cut																	
Street Runner™ - Hot pressed - long life																	
Type 1 Wheels for Stationary Cut-off Saws																	
A24N - Fast Cutting	•	•	•	•	•		•	•	•	•				•	•		•
A24R - Long Life	•	•		•	•	•	•		•	•					•		•
A36R - Burr-Free		•			•		•							•	•		•
C24R - Concrete																	
Metal-Cutting Carbide Blades																	
Type 1 (41) Thin High Speed Cut-off Wheels																	
A24R - General Purpose	•	•					•		•		•	•	•			•	•
A36T - Fast Cutting	•	•					•				•	•	•			•	•
A60T - Burr-Free							•				•	•					
Saitech Ultimate Performance™ - Ceramic High Performance				•				•						•			
Type 11 Cup Wheels																	
A16 - General Purpose						•			•					•	•		•
Z16 - Zirconium						•			•					•	•		•
C16 - Concrete			•														
CA16 - Combination				•		•											
Type 16,17,18 Cones & Plugs																	
Resin Bonded Mounted Points																	

* Indicates most common usages

Cutting & Grinding Application Chart

Non-Ferrous Metals *				Stone *						Other *				Page in Catalog	
Aluminum	Brass	Bronze	Copper	Asphalt	Brick	Ceramic	Concrete	Granite	Green Concrete	Marble	Masonry	Fiberglass	Plastic		Wood
															14
															14
															14
					•	•	•	•	•	•	•				18
															17
															15
															15
•															16
															16
															16
															19
															19
															20
•	•	•	•									•	•	•	21
															28
															28-29
															29
															43
•	•	•	•		•	•	•	•	•	•	•				42
															45
•			•												36
															36
															37
															45
															50
															50-51
•	•	•	•												51
															51
															52
															52
															38
•	•	•	•		•		•				•			•	39
															54
															53
															53
					•	•	•	•	•	•	•		•		54
															55
					•		•		•		•				54
					•		•		•		•				55
					•		•		•		•				55
															56
															56
•	•	•	•		•	•	•			•	•				56
•	•	•	•		•	•	•			•	•				57
															60-61
													•	•	46
															46-47
															46-47
															46
															22
															22
							•	•		•	•				23
							•	•		•	•				23
															25
															24

* Indicates most common usages

How To Use This Chart

This chart should be used as a reference to match wheel to application. Following these steps will help you utilize this chart to choose the wheel that will best suit your needs.



STEPS IN SELECTING A WHEEL

1. Select the material you will be using based upon the choices at the top of the chart.
2. Determine what you want to do to this material?
 - Are you cutting?
 - Are you grinding?
 - Are you cutting and grinding?
 - Are you finishing?
3. What tools do you have available?
4. Once you have followed these steps, select the wheel that will best suit your needs and turn to that page to see more specifications on that product.

UNITED
ABRASIVES, INC.

SAIT



Exclusive Super-Lock™ Hub

Super-Lock™ combines a mechanically interlocked transversed key lock system with a unique two-part bonding system to give it superior performance capabilities. Other manufacturers use hubs that depend only on two-part epoxy which can fail in many instances due to poor surface preparation, improper curing conditions, incorrect ratio of catalyst and epoxy, or the quantity of epoxy material applied.

Unique in the industry

The United Abrasives Super-Lock™ system is our exclusive, fail-safe throw-away hub assembly. This is a unique hubbing system that is used on Type 27 and Type 28 grinding and cutting wheels where hub mounting is preferred.

Unsurpassed Performance

The rotational torque placed upon wheels can vary based on material being removed and pressure that is applied. While the chemical bonds that other manufacturers use can fail, the Super-Lock™ Hub ensures the stability of the hub-to-wheel connection.

Millions sold - Not one Failure

Since 1983, United Abrasives has manufactured and sold millions of depressed center wheels with Super-Lock™ Hubs. Not a single one has ever been reported as a failure.

Patented

The Super-Lock™ Hub system is so safe that it was originally protected by United States patent #4,541,205. United Abrasives is the only manufacturer to utilize this outstanding hub system.

Use on Type 27 and Type 28 Wheels

The Super-Lock™ Hub System is available on 4-1/2", 5", 6", 7" and 9" Type 27 and Type 28 depressed center grinding and cutting wheels. Turbo 5" x 1/8", .045" wheels, .090" wheels, .095" wheels and flap discs do not have Super-Lock™ Hubs but use a non-keyway hub with the same unique two-part bonding system.

Look for this drawing throughout the catalog indicating the wheels that are available with the Super-Lock™ Hub.

Unique two-part epoxy bonding system applied to the hub area



Mechanical Locking System that fits into keyway



Exclusive Fail-Safe Hub

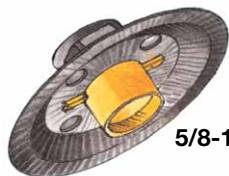

5/8-11 Super-Lock™ Hub

GRINDING



- This section contains eleven 1/4" thick grinding specifications (Type 27, 28 and 29).
- You will also find Cones, Plugs, Cup Stones, Mounted Points, Challenger II, and Challenger 3.

TYPE 27

General Purpose

A24N - BF
GENERAL PURPOSE GRINDING ON ALL FERROUS METALS & STAINLESS STEEL
7 x 1/4
TYPE 27
MAX. RPM 8,500
S&H HUB-20088

A24R-BF
LONG LIFE GRINDING ON ALL FERROUS METALS & STAINLESS STEEL
7 x 1/4
TYPE 27
MAX. RPM 8,500
S&H HUB-20088

Pg. 14

High Performance

ULTIMATE GRIND
LONG LIFE GRINDING ON ALL FERROUS METALS & STAINLESS STEEL
4-1/2 x 1/4
TYPE 27
MAX. RPM 13,300

Pg. 15

High Performance

SAIT Z-tech
LONG LIFE GRINDING ON STAINLESS & ALL FERROUS METALS
7 x 1/4
TYPE 27
R/A Arbor: 22088

Pg. 15

Aluminum

SAIT ALUMINUM
A46N - BF
QUICK ACTION GRINDING ON ALUMINUM & NON FERROUS METALS
7 x 1/4
TYPE 27
MAX. RPM 8,500
S&H HUB-20088

Pg. 17

TYPE 28

SAITECH
LONG LIFE GRINDING ON ALL FERROUS METALS & STAINLESS STEEL
9 x 1/4
TYPE 28
MAX. RPM 8,500
S&H HUB-20088

Pgs. 19-20

PAGES 14-17

A24N
Fast Grinding

A24R
Long Life

A24T
Edge Grinding

The Ultimate Grind™
High performance grinding for the toughest applications

Sait Z-tech™
Extremely Fast Stock Removal

Special Zirconium Grain

Can be used on Stainless Steel

A46N

Extremely Fast Stock Removal

Non-loading Formula

PAGES 19-20

A24N
A24R
Saitech Ultimate Performance™

TYPE 27

Stainless Steel

SAIT STAINLESS
KA24Q - BF
GENERAL PURPOSE GRINDING ON ALL STAINLESS STEEL
4-1/2 x 1/4
TYPE 27
MAX. RPM 13,300
S&H HUB-20088

Pg. 16

Stainless Steel

SAITECH
LONG LIFE GRINDING ON ALL FERROUS METALS & STAINLESS STEEL
4-1/2 x 1/4
TYPE 27
MAX. RPM 13,300

Pg. 16

Concrete

SAIT GRIND
C24N - BF
LONG LIFE GRINDING ON ALL FERROUS METALS & STAINLESS STEEL
7 x 1/4
TYPE 27
MAX. RPM 8,500
S&H HUB-20088

Pg. 18

PAGES 16-18

XA24Q
Contaminant-Free Grinding
contaminant (cf) free
Free of Iron, Sulphur & Chlorine

Saitech Attacker®
Fast Grinding

Saitech Ultimate Performance™
Long Life

C24N
General Purpose Grinding on Masonry, Concrete and Stone

Challenger II & 3

Challenger 3
4 1/2 x 7/8
TYPE 29 - A36
MAX. RPM 13,300
S&H HUB-20088

Pg. 21

Mounted Points

Pg. 24

Cones & Plugs

Pg. 25

Cup Stones

SAIT Cup Stone
LONG LIFE GRINDING ON ALL FERROUS METALS & STAINLESS STEEL
MAX. RPM 8,500
S&H HUB-20088

Pg. 22-23

Grinding

1/4"

TYPE 27 Depressed Center Wheels

GRINDING
WHEELS

GENERAL PURPOSE



A24N - Fast Grinding

- Aluminum oxide grain
- Soft bond for **fast stock removal**

METAL Ferrous Metals (iron, steel, welds, etc.)

STAINLESS Low grade stainless steel

A24R - Long Life

- Aluminum oxide grain - our most popular wheel
- For general purpose grinding
- **Longer life** for fewer wheel changes

METAL Ferrous Metals (iron, steel, welds, etc.)

A24T - Edge Grinding

- Aluminum oxide grain
- Hard bond designed for **edge and bevel grinding** and other applications where a harder wheel is preferred
- **Longer life** for fewer wheel changes

METAL Ferrous Metals (iron, steel, welds, etc.)

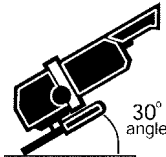

Angle Grinder



5/8-11 Super-Lock™ Hub

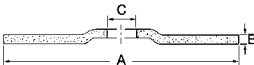

Size			Max RPM	Grades Available			Qty Per Box	Qty Per Ctn	Lbs Per Box
A Dia.	B Width	C Bore		A24N	A24R	A24T			
3	1/4	3/8	18,000	20002	-	-	25	100	4
4	1/4	3/8	13,500	20012	-	-	25	100	7
4	1/4	5/8	13,500	20015	20013	-	25	100	7
4-1/2	3/16	7/8	13,300	20050	-	-	25	100	8
4-1/2	3/16	5/8-11	13,300	20150	-	-	10	40	5
4-1/2	1/4	7/8	13,300	20060	20063	20065	25	100	9
4-1/2	1/4	5/8-11	13,300	20160	20163	20165	10	40	6
5	1/4	7/8	12,200	20070	20073	20075	25	100	11
5	1/4	5/8-11	12,200	20170	20173	20175	10	40	6
6	1/4	7/8	10,200	20078	20079	20280	25	50	18
6	1/4	5/8-11	10,200	20178	20076	20180	10	40	10
7	1/4	7/8	8,500	20081	20080	20285	25	50	24
7	1/4	5/8-11	8,500	20085	20086	20185	10	40	14
9	1/4	7/8	6,600	20091	20090	20295	25	50	42
9	1/4	5/8-11	6,600	20095	20096	20195	10	40	20



Quick Tip

The "softer" a grinding wheel is (A24N) the faster it will remove metal.

Tech INFO

- Virgin aluminum oxide grain assures consistent high stock removal for tough applications
- All sizes are made with uniform grain throughout, no filler grain used in the backing
- All wheels internally reinforced with the highest quality fiberglass for maximum safety
- Our unique Super-Lock™ Hub combines both a mechanical locking system and chemical bond providing one of the safest, vibration-free designs in the industry

TYPE 27 Depressed Center Wheels

Grinding 1/4"

GRINDING
WHEELS

HIGH PERFORMANCE



The Ultimate Grind™

- Proprietary grain and bond system
- High performance grinding for the toughest applications

METAL Ferrous metals (iron, steel, welds)

STAINLESS Stainless steel, high tensile alloys

Z24R - Zirconium

- Tough zirconium grain
- High performance grinding for the toughest applications

METAL Ferrous metals (iron, steel, welds)

STAINLESS Stainless steel, high tensile alloys

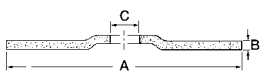

5/8-11 Super-Lock™ Hub

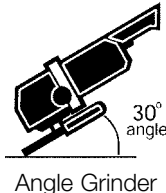

Angle Grinder

Size			Max RPM	Grades Available		Qty Per Box	Qty Per Ctn	Lbs Per Box
A Dia.	B Width	C Bore		Ult. Grind™	Z24R			
4	1/4	5/8	13,500	-	22599	25	100	7
4-1/2	1/4	7/8	13,300	22414	22600	25	100	9
4-1/2	1/4	5/8-11	13,300	22514	22610	10	40	6
5	1/4	7/8	12,200	22415	22602	25	100	12
5	1/4	5/8-11	12,200	22515	22612	10	40	6
6	1/4	7/8	10,200	22416	22603	25	50	20
6	1/4	5/8-11	10,200	22516	22613	10	40	9
7	1/4	7/8	8,500	22417	22604	25	50	25
7	1/4	5/8-11	8,500	22517	22614	10	40	14
9	1/4	7/8	6,600	22419	22606	25	50	42
9	1/4	5/8-11	6,600	22519	22616	10	40	21



- The highest quality zirconium grain
- All sizes made with uniform grain throughout, no filler grain used
- Our unique Super-Lock™ Hub combines both a mechanical locking system and chemical bond providing one of the safest, vibration-free designs in the industry

Grinding

1/4"

TYPE 27 Depressed Center Wheels

GRINDING
WHEELS

CONTAMINANT-FREE/STAINLESS STEEL



Saitech Attacker®

- High performance, ceramic aluminum oxide grain
- Very uniform, high density grain structure is extremely durable and self sharpening for long life and cooler cut
- Extremely fast stock removal on hard metals with minimal pressure

STAINLESS Stainless steel and other high tensile alloys

METAL Ferrous metals (iron, steel, welds, etc.)

Saitech Ultimate Performance™

- High performance, ceramic aluminum oxide grain
- Very uniform, high density grain structure is extremely durable and self sharpening for long life and cooler cut
- Combines fast stock removal with long life

STAINLESS Stainless steel and other high tensile alloys

METAL Ferrous metals (iron, steel, welds, etc.)

XA24Q - Contaminant-Free

- Specially formulated for nuclear and food processing plants where the need for contaminant-free stock removal on stainless steel is a concern
- Free of iron, chlorine and sulphur compounds (Fe + Cl + S <0.1%)

STAINLESS Stainless steel and other high tensile alloys

METAL Ferrous metals (iron, steel, welds, etc.)

contaminant **cf** free

- Will not contaminate stainless steel

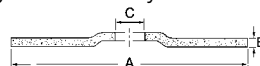

Size			Max RPM	Grades Available			Qty Per Box	Qty Per Ctn	Lbs Per Box
A Dia.	B Width	C Bore		Part Numbers					
4	1/4	3/8	13,500	-	20112	-	25	100	7
4	1/4	5/8	13,500	-	20014	-	25	100	8
4-1/2	1/4	7/8	13,300	20046	20064	24210	25	100	11
4-1/2	1/4	5/8-11	13,300	20146	20164	-	10	40	6
5	1/4	7/8	12,200	20047	20074	24215	25	100	13
5	1/4	5/8-11	12,200	20147	20174	-	10	40	8
6	1/4	7/8	10,200	-	-	24220	25	50	20
7	1/4	7/8	8,500	20048	20084	24225	25	50	28
7	1/4	5/8-11	8,500	20148	20089	-	10	40	14
9	1/4	7/8	6,600	20049	20094	24230	25	50	43
9	1/4	5/8-11	6,600	20149	20099	-	10	40	21

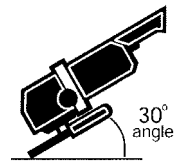

Angle Grinder

Tech INFO

- Saitech™, manufactured with patented 3M™ ceramic abrasive grain, is designed to outlast standard aluminum oxide wheels (3M is a trademark of 3M Company)
- Special bonding formula allows for very fast stock removal on many types of metals
- Designed to provide very long life for fewer wheel changes and less downtime
- All sizes reinforced with the highest quality fiberglass for maximum safety and performance
- Our unique Super-Lock™ Hub combines both a mechanical locking system and chemical bond providing one of the safest, vibration-free designs in the industry

TYPE 27 Depressed Center Wheels

Grinding
1/4"

GRINDING
WHEELS

ALUMINUM

A46N - Aluminum

- Aluminum oxide grain
- Soft bond for aggressive removal of material without loading
- Outlasts competition by as much as 40%

ALUMINUM Non-ferrous metals
(aluminum, copper, brass, etc.)

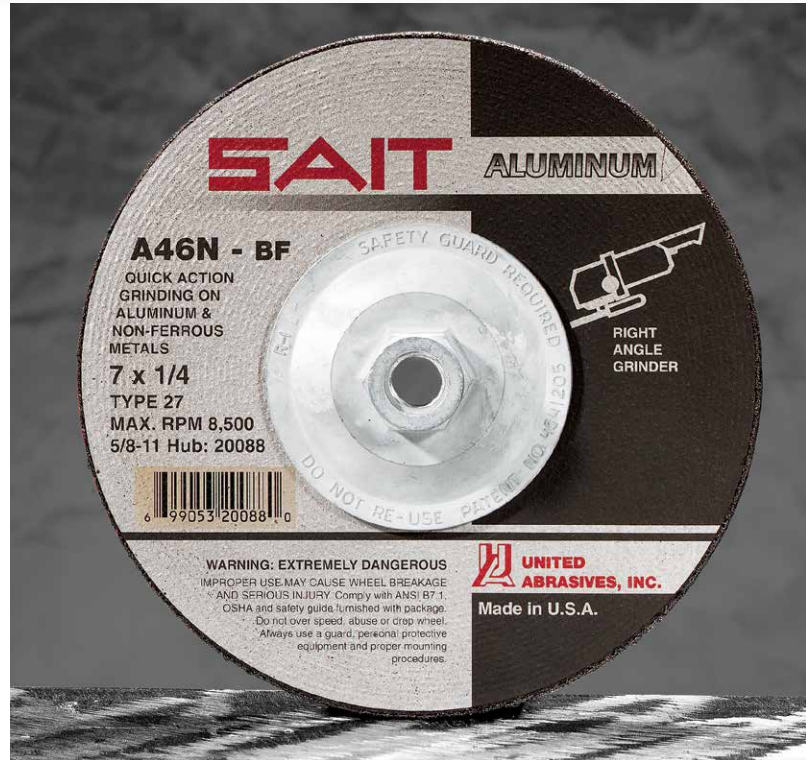

See pages 30-31 for Cotton Fiber grinding and blending products for aluminum

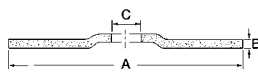

Size			Max RPM	Part Number	Qty Per Box	Qty Per Ctn	Lbs Per Box
A Dia.	B Width	C Bore					
4	1/4	5/8	13,500	20018	25	100	7
4-1/2	1/4	7/8	13,300	20062	25	100	9
4-1/2	1/4	5/8-11	13,300	20162	10	40	6
5	1/4	7/8	12,200	20072	25	100	11
5	1/4	5/8-11	12,200	20172	10	40	6
7	1/4	7/8	8,500	20083	25	50	24
7	1/4	5/8-11	8,500	20088	10	40	13

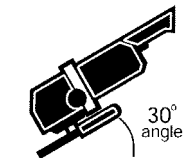

Angle Grinder

Tech
INFO

- Special aluminum oxide formulation prevents "loading" on soft (non-ferrous) metals
- All sizes internally reinforced with the highest quality fiberglass for maximum safety and performance
- Our unique Super-Lock™ Hub combines both a mechanical locking system and chemical bond providing one of the safest, vibration-free designs in the industry

Grinding

1/4"

TYPE 27 Depressed Center Wheels

GRINDING
WHEELS

CONCRETE



C24N - Concrete

- Silicon carbide grain
- Soft bond for fast stock removal

CONCRETE Masonry, concrete, stone

METAL Cast iron and other ferrous metals

QT Quick Tip

Use the C24N wheel on hard to grind metal like cast iron.

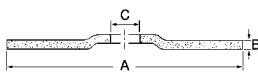

Size			Max RPM	Part Number	Qty Per Box	Qty Per Ctn	Lbs Per Box
A Dia.	B Width	C Bore					
4-1/2	1/4	7/8	13,300	20061	25	100	8
4-1/2	1/4	5/8-11	13,300	20161	10	40	6
5	1/4	7/8	12,200	20071	25	100	10
5	1/4	5/8-11	12,200	20171	10	40	6
7	1/4	7/8	8,500	20082	25	50	24
7	1/4	5/8-11	8,500	20087	10	40	12
9	1/4	7/8	6,600	20092	25	50	33
9	1/4	5/8-11	6,600	20097	10	40	7

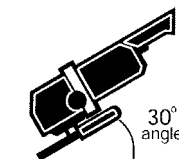

Angle Grinder

Tech INFO

- Special silicon carbide grain formula is excellent for grinding masonry, concrete, stone and aggregate
- All sizes reinforced with the highest quality fiberglass for maximum safety and performance
- Our unique Super-Lock™ Hub combines both a mechanical locking system and chemical bond providing one of the safest, vibration-free designs in the industry

TYPE 28 Depressed Center Wheels

Grinding 1/4"

GRINDING
WHEELS

GENERAL PURPOSE

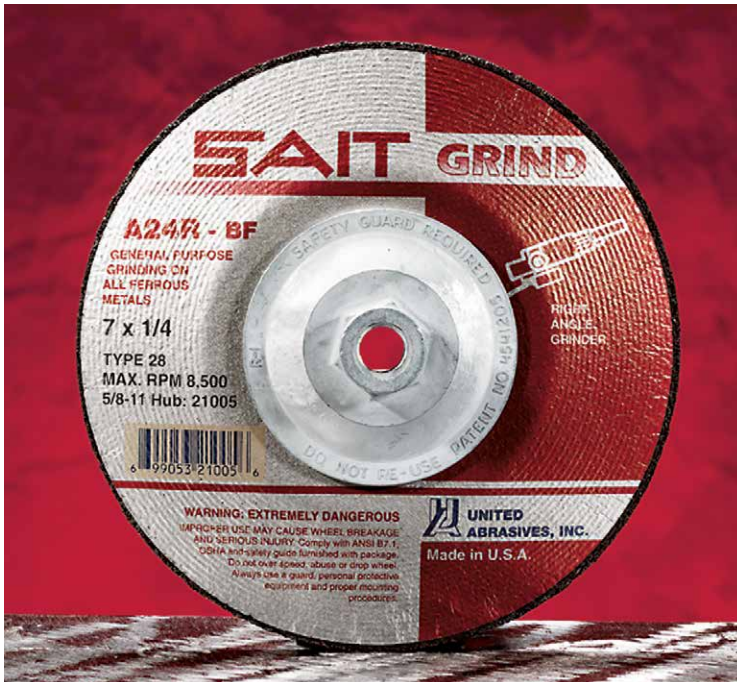

A24N - Fast Grinding

- Aluminum oxide grain
- Soft bond for fast stock removal

METAL

Ferrous metals (iron, steel, welds, etc.)

STAINLESS

Low-grade stainless steel

A24R - Long Life

- Aluminum oxide grain
- Medium bond for longer life and fewer wheel changes

METAL

Ferrous metals (iron, steel, welds, etc.)



Quick Tip

Use this saucer shape for uniform grinding of large flat surfaces.

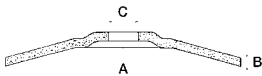

Size			Max RPM	Grades Available		Qty Per Box	Qty Per Ctn	Lbs Per Box
A Dia.	B Width	C Bore		Part Number				
				A24N	A24R			
4-1/2	1/4	7/8	13,300	21020	21021	25	100	9
4-1/2	1/4	5/8-11	13,300	21025	21026	10	40	6
7	1/4	7/8	8,500	-	21000	25	50	23
7	1/4	5/8-11	8,500	-	21005	10	40	13
9	1/4	7/8	6,600	-	21010	25	50	38
9	1/4	5/8-11	6,600	-	21015	10	40	19

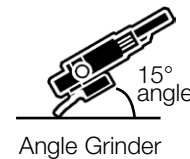

Angle Grinder



5/8-11 Super-Lock™ Hub

Tech INFO

- Type 28 saucer shape (see diagram above) allows greater surface area coverage and provides the operator with greater grind visibility
- Additional fiberglass reinforcement for maximum safety in high lateral pressure applications
- Our unique Super-Lock™ Hub combines both a mechanical locking system and chemical bond providing one of the safest, vibration-free designs in the industry

Grinding

1/4"

TYPE 28

Saitech High Performance Wheels

Saitech Ultimate Performance™

- High performance, ceramic aluminum oxide grain
- Very uniform, high density grain structure is extremely durable and self sharpening for long life and cooler cut
- Exclusive formula with patented 3M™ ceramic abrasive grain
- Combines maximum material removal with long life

STAINLESS Stainless steel

METAL Ferrous metals (iron, steel, welds, etc.)

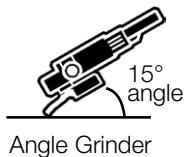
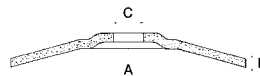

Size			Max RPM	Part Number	Qty Per Box	Qty Per Ctn	Lbs Per Box
A Dia.	B Width	C Bore					
7	1/4	7/8	8,500	21084	25	50	23
7	1/4	5/8-11	8,500	21089	10	40	12
9	1/4	7/8	6,600	21094	25	50	34
9	1/4	5/8-11	6,600	21099	10	40	19



- Type 28 saucer shape (see diagram above) allows greater surface area coverage and provides the operator with greater grind visibility
- Saitech™, manufactured with patented 3M™ ceramic abrasive grain, is designed to outlast standard aluminum oxide wheels (3M is a trademark of 3M Company)
- Additional fiberglass reinforcement for maximum safety in high lateral pressure applications
- Our unique Super-Lock™ Hub combines both a mechanical locking system and chemical bond providing one of the safest, vibration-free designs in the industry

TYPE 29

Blending

Flexible Grinding/Blending Wheels

GRINDING
WHEELS

SPECIALTY



Challenger II™

- Aluminum oxide grain
- Open pattern on wheel for cool grinding and blending
- Safe for use in the nuclear industry

PROPER CLAMPING PROCEDURES

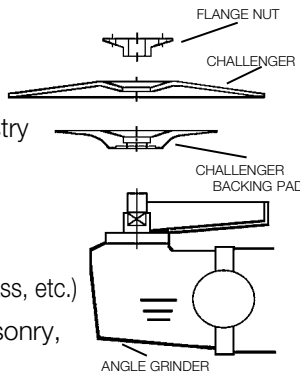

- | | |
|------------------|--|
| METAL | Steel, iron, bronze |
| STAINLESS | Stainless steel |
| ALUMINUM | Non-ferrous metals (aluminum, copper, brass, etc.) |
| CONCRETE | Also for use on masonry, plastic, fiberglass |

Packaging

Each box of 25 supplied with a backing pad and one 5/8-11 nut
Additional pad assembly:
4-1/2" & 5" - #95245
7" - #95247
For additional pads & nuts see pg. 142

Quick Tip
Use Challenger II™ for longer life in aggressive applications.

contaminant **cf** free



Challenger 3

High Performance

- Semi-Flexible
- Grind and blend welds in one step
- Open pattern on wheel for cool grinding and blending
- Contaminate Free - Safe for use in the nuclear industry

- | | |
|------------------|--|
| STAINLESS | Stainless steel |
| METAL | Steel, iron, bronze |
| ALUMINUM | Non-ferrous metals (aluminum, copper, brass, etc.) |

REQUIRES NO BACKING PAD!

contaminant **cf** free

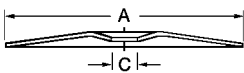
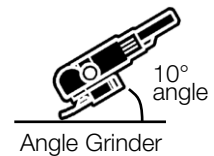
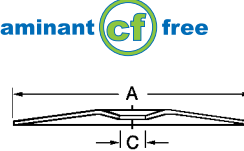

Size		Max RPM	Part Numbers/Grits Challenger II™				Qty Per Box	Lbs Per Box
A Dia.	C Bore		24	36	60	100		
4-1/2	7/8	13,280	-	27500	27501	27502	25	6
5	7/8	12,200	-	27506	27507	27508	25	5
7	7/8	8,600	27510	27511	27512	27513	25	14

Size		Max RPM	Part Numbers/Grits Challenger 3		Qty Per Box	Lbs Per Box
A Dia.	C Bore		36	60		
4-1/2	7/8	13,280	27610	27611	10	3
5	7/8	12,200	27615	27616	10	3

Tech
INFO

- Type 29 shape (see diagram above) allows easy control in grinding and blending applications
- Honeycomb, dimpled pattern on face allows for greater cooling action and longer life
- Grind and blend welds in one-step, no need for multiple steps and products
- Available in many grits for all your grinding and blending needs



Z16 - Zirconium

- Special zirconium grain formulation
- Coarse grit and hard bond for the toughest grinding applications
- Outlasts standard aluminum oxide cup wheels 2:1

- METAL** Ferrous metals
- STAINLESS** Stainless steel

A16 - General Purpose

- Aluminum oxide grain
- Coarse grit wheel for tough grinding applications
- Excellent for cleaning castings, mold marks, removing flashing

- METAL** Ferrous metals

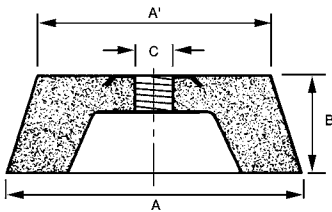

Available with an optional metal backing

Size				Grades Available	Max RPM	Part Number	MB*	Qty Per Box	Lbs Per Box
A Dia.	A' Dia.	B Width	C Bore						
4	3	2	5/8-11	A16	9,050	26000	26003	12	25
5	4	2	5/8-11	A16	7,250	26010	26013	6	20
5	4	2	5/8-11	Z16	7,250	26050	26053	6	23
6	4-3/4	2	5/8-11	A16	6,050	26020	26023	5	25
6	4-3/4	2	5/8-11	Z16	6,050	26060	26063	5	25

MB* = metal backing



Angle Grinder



- Type 11 shape (see diagram above) provides maximum surface area coverage for grinding and cleaning applications
- Offered with a metal-backed option for greater stability in high-pressure applications

TYPE 11 Cup Stones

Grinding

CUP
STONES

CONCRETE



C16 - Concrete

- Silicon carbide grain
- Coarse grit for tough grinding applications
- Excellent for cleaning castings, mold marks, and removing flashing

CONCRETE Masonry, concrete, stone

CA16 - Combination

- Combination of aluminum oxide and silicon carbide grains
- Excellent for cleaning castings, mold marks, and removing flashing

METAL Use on combination of ferrous metals

CONCRETE and/or concrete materials

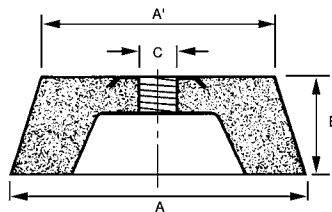

Available with an optional metal backing



Angle Grinder

Size				Grades Available	Max RPM	Part Number	MB*	Qty Per Box	Lbs Per Box
A Dia.	A' Dia.	B Width	C Bore						
4	3	2	5/8-11	C16	9,050	26001	26004	12	21
4	3	2	5/8-11	CA16	9,050	26002	26005	12	24
5	4	2	5/8-11	C16	7,250	26011	26014	6	17
5	4	2	5/8-11	CA16	7,250	26012	26015	6	19
6	4-3/4	2	5/8-11	C16	6,050	26021	26024	5	20
6	4-3/4	2	5/8-11	CA16	6,050	26022	26025	5	30

MB* = metal backing

Tech INFO

- Type 11 shape (cup shape) is excellent for maximum surface area coverage for foundry and cleaning applications
- Available in popular sizes for right angle grinders on the market
- Metal-back option provides greater stability in tough grinding applications

A36Q - Resin Bonded

- Aluminum oxide grain
- For deburring and finishing
- **Fast stock removal**

METAL Ferrous metals (iron, steel, welds)

- Shank length 1-1/2"



Mandrel overhang "O" must always be the lowest possible. Maximum speeds given refer to overhang "O" equal to 1/2"



Die Grinder

A60R - Vitrified

- Aluminum oxide grain
- **Ideal for ID grinding and mold finishing**

METAL Ferrous metals

- Shank length 1-1/2"

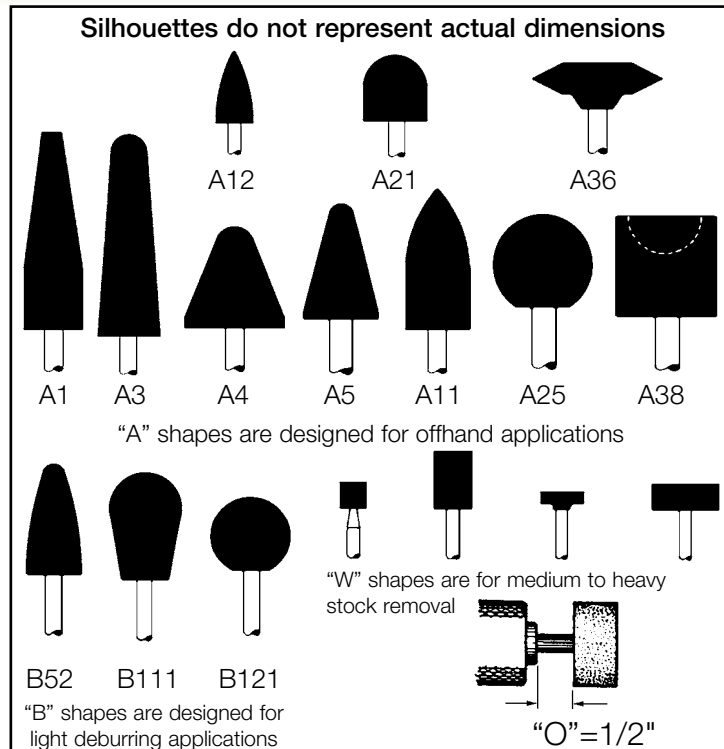

Type	Size		Shank Dia.	A36Q Part Number	A60R Part Number	"O" = 1/2" Max RPM	Qty Per Box
	Dia.	Length					
A1	3/4	2-1/2	1/4	27401	27010	19,800	10
A3	1	2-3/4	1/4	27402	27020	16,100	10
A4	1-1/4	1-1/4	1/4	27403	27030	30,560	10
A5	3/4	1-1/8	1/4	27404	27035	45,000	10
A11	7/8	2	1/4	27405	27040	19,860	10
A12	11/16	1-1/4	1/4	-	27050	48,000	10
A21	1	1	1/4	-	27060	34,500	10
A25	1	Round	1/4	-	27070	35,620	10
A36	1-5/8	3/8	1/4	-	27086	23,520	10
A38	1	1	1/4	27406	27088	34,500	10
B52	3/8	3/4	1/4	27407	-	45,370	10
B52	3/8	3/4	1/8	-	27110	45,370	20
B111	7/16	11/16	1/8	-	27120	33,750	20
B121	1/2	1/2	1/8	-	27130	45,370	20
W160	1/4	1/4	1/8	-	27308	81,370	10
W177	3/8	3/4	1/8	-	27310	33,750	20
W179	3/8	1-1/4	1/4	27408	-	45,750	10
W189	1/2	2	1/4	27409	27327	24,000	10
W196	5/8	1	1/4	-	27329	35,250	10
W204	3/4	3/4	1/4	27410	27320	42,750	10
W208	3/4	2	1/4	27411	27330	18,750	10
W215	1	1/8	1/8	-	27338	38,200	10
W220	1	1	1/4	27412	27360	25,500	10
W222	1	2	1/4	27413	27340	15,900	10
W225	1-1/4	1/4	1/4	-	27350	30,560	10
W236	1-1/2	1/2	1/4	27414	27349	25,470	10



- These mounted bonded points are a low cost alternative to carbide burs
- Each point is dressed for perfect dia. to perform without vibration or run-out

TYPE 16, 17, 18 Cones & Plugs

Grinding

CONES & PLUGS

GENERAL PURPOSE



Cones and Plugs

- Aluminum oxide grain
- For grinding and snagging in hard to reach areas
- **Fast stock removal**

METAL Ferrous metals
(iron, steel, welds, etc.)

Packaging
10 per box



Die Grinder

Type 16 Cone

Size			Grade Available	Max RPM	Part No.	Qty Per Box	Lbs Per Box
A Dia.	B Length	C Bore					
1	3	3/8-24	A20	36,300	24999	10	3
1-1/4	3	3/8-24	A16	29,000	25000	10	3
2	3	3/8-24	A16	18,100	25005	10	6
2	3	5/8-11	A16	18,100	25006	10	7
2-3/4	3-1/2	5/8-11	A16	13,200	25008	10	13
3	3	5/8-11	A20	12,000	25009	10	16

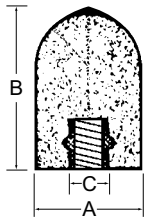

Type 17 Cone

1-1/2	2-1/2	3/8-24	A20	24,100	25101	10	3
1-1/2	2-1/2	5/8-11	A20	24,100	25102	10	3
1-1/2	3	3/8-24	A16	24,100	25103	10	3
1-1/2	3	5/8-11	A16	24,100	25104	10	4
2	3	3/8-24	A16	18,100	25105	10	6
2	3	5/8-11	A16	18,100	25106	10	5



Type 18 Plug

1	3	3/8-24	A20	36,300	25200	10	4
1-1/2	2-1/2	3/8-24	A20	24,100	25201	10	5
1-1/2	2-1/2	5/8-11	A20	24,100	25202	10	5
1-1/2	3	3/8-24	A16	24,100	25203	10	5
1-1/2	3	5/8-11	A16	24,100	25204	10	6
2	3	3/8-24	A16	18,100	25205	10	10
2	3	5/8-11	A16	18,100	25206	10	11



Type 18R Plug

1	3	3/8-24	A20	36,300	25300	10	3
1-1/2	2-1/2	3/8-24	A20	24,100	25301	10	5
1-1/2	2-1/2	5/8-11	A20	24,100	25302	10	5
1-1/2	3	3/8-24	A16	24,100	25303	10	6
1-1/2	3	5/8-11	A16	24,100	25304	10	6
2	3	3/8-24	A16	18,100	25305	10	8
2	3	5/8-11	A16	18,100	25306	10	9



Tech
INFO

- Available in the most common application shapes
- Large grit size for heavy-duty grinding and snagging

"THE ULTIMATE" Product Line

THE BEST GETS EVEN BETTER!

THE ULTIMATE™ grind



NEW!

Premium Performance!

- Proprietary grain and bond system
- High performance grinding for the toughest applications

METAL STAINLESS

THE ULTIMATE™ pipeline

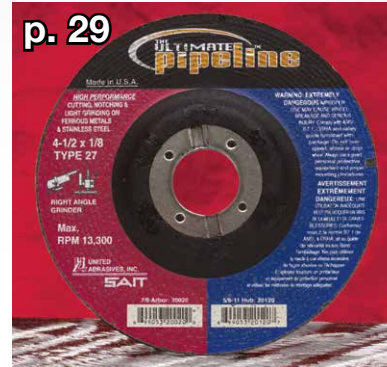

NEW!

Premium Performance!

- Proprietary grain and bond system
- Fast, free-cutting with exceptional life
- Premium performance cutting and light grinding for the toughest applications

METAL STAINLESS

THE ULTIMATE™ cut



- Best in class – cutting a wide range of **STAINLESS** thin & thick gauge, flat stock, bar stock, square tubing, etc.
- Exceptional cutting performance on

METAL ALUMINUM

Premium Performance!

THE ULTIMATE™ ceramic CUT-OFF

NEW!



- Premium ceramic aluminum oxide grain
- Exceptionally long-lasting on carbon steel, stainless steel, and hard to grind alloys
- Maximizes productivity

METAL STAINLESS

Premium Performance!

4 in 1 THE ULTIMATE™ combo

CUT • NOTCH • DEBUR • LIGHT GRIND

A60S - General Purpose

- Aluminum oxide grain
- Consistent performance with long life for cutting, notching, deburring, & light grinding

26

METAL



Now Available in 6"

Premium Performance!

Z-Tech High Performance

- Tough zirconium grain
- High performance cutting, notching, deburring, and light grinding for the toughest applications

METAL STAINLESS

PIPELINE INTRODUCTION



PIPELINE
WHEELS

- This section contains four 1/8" thick specifications
- Designed and manufactured to perform both cutting and light grinding
- Pipeline wire brushes also available (pages 135-136)



A24R Pipeline
General Purpose



Z24R
High Performance



The Ultimate Pipeline™
Premium Performance

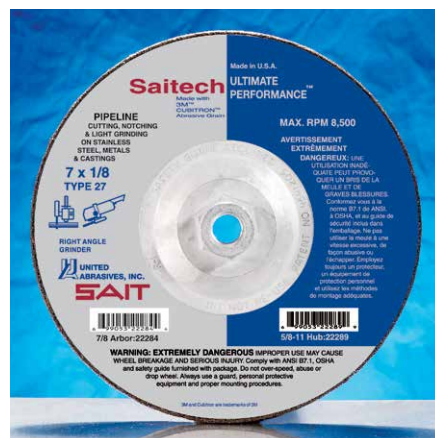

Saitech™ Pipeline
High Performance
Stainless Steel

A24R Pipeline - General Purpose

- Aluminum oxide grain
- Designed and manufactured to perform both cutting and light grinding

METAL Ferrous metals (steel, cast iron, etc.)

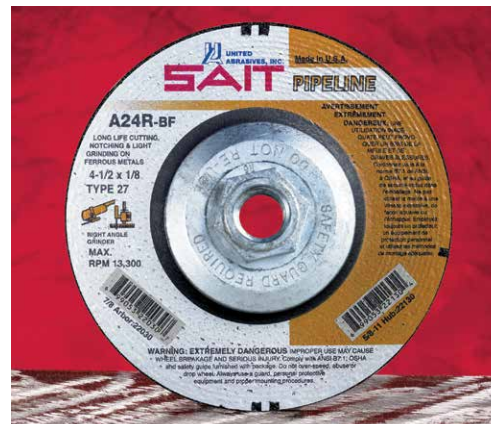

Z24R

- Tough zirconium grain
- High performance cutting and light grinding for the toughest applications

METAL Ferrous metals (iron, steel, welds)

STAINLESS Stainless steel, high tensile alloys

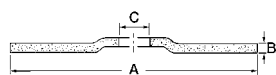

Size			Max RPM	Part Number		Qty Per Box	Qty Per Ctn	Lbs Per Box
A Dia.	B Width	C Bore		Pipeline	Z-tech™			
4	1/8	3/8	13,500	22007	-	25	100	4
4	1/8	5/8	13,500	22015	-	25	100	4
4-1/2	1/8	7/8	13,300	22030	22620	25	100	6
4-1/2	1/8	5/8-11	13,300	22130	22630	10	40	5
5	1/8	7/8	12,200	22040	22622	25	100	7
5	1/8	5/8-11	12,200	22140	22632	10	40	5
6	1/8	7/8	10,200	22042	22623	25	50	10
6	1/8	5/8-11	10,200	22046	22633	10	40	8
7	1/8	7/8	8,500	22055	22624	25	50	15
7	1/8	5/8-11	8,500	22052	22634	10	40	10
9	1/8	7/8	6,600	22065	22626	25	50	25
9	1/8	5/8-11	6,600	22062	22636	10	40	13

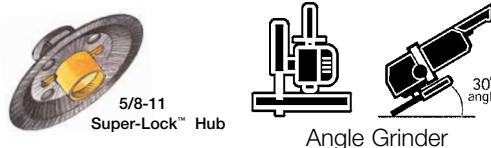

Note: Reusable 5/8-11 adaptor for use on Type 1 and Type 27 reinforced wheels with a 7/8 arbor, a max. diameter of 5" and a wheel thickness of .045 to 1/8" available on page 143 (part #95055).



Also available:
Pipeline Brushes
page 136



- Designed for both cutting and light grinding, eliminating the need for 2 separate wheels
- General purpose formulation provides optimum performance over a wide range of applications
- All sizes reinforced with the highest quality fiberglass for maximum safety and performance
- Our unique Super-Lock™ Hub combines both a mechanical locking system and chemical bond providing one of the safest, vibration-free designs in the industry

TYPE 27

Specialty Pipeline Wheels

Cutting/Grinding

1/8"

PIPELINE
WHEELS

STAINLESS STEEL/HIGH PERFORMANCE



The Ultimate Pipeline™

- Proprietary grain and bond system
- Fast, free-cutting with exceptional life
- **Premium performance cutting and light grinding for the toughest applications**



- METAL** Ferrous metals (iron, steel, welds)
- STAINLESS** Stainless steel, high tensile alloys

Saitech™ Pipeline

- High performance, ceramic aluminum oxide grain
- **Very uniform, high density grain structure is extremely durable and self sharpening for long life and cooler cut**
- Designed and manufactured to perform both high performance cutting and light grinding
- **Long life combined with versatility for the pipeline industry**

- STAINLESS** Stainless steel, high tensile alloys
- METAL** Ferrous metals (iron, steel, welds, etc.)

- **High performance cutting and light grinding on stainless steel**

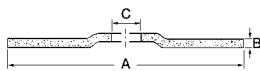

Size			Max RPM	Part Number		Qty Per Box	Qty Per Ctn	Lbs Per Box	
A Dia.	B Width	C Bore		Ult. Pipe™	Saitech™			Z-tech™	Saitech™
4-1/2	1/8	7/8	13,300	20020	22264	25	100	6	7
4-1/2	1/8	5/8-11	13,300	20120	22269	10	40	5	5
5	1/8	7/8	12,200	20025	22274	25	100	8	8
5	1/8	5/8-11	12,200	20125	22279	10	40	11	10
6	1/8	7/8	10,200	20030	-	25	100	11	-
6	1/8	5/8-11	10,200	20130	-	10	40	8	-
7	1/8	7/8	8,500	20035	22284	25	50	17	20
7	1/8	5/8-11	8,500	20135	22289	10	40	9	10
9	1/8	7/8	6,600	20040	22294	25	50	26	32
9	1/8	5/8-11	6,600	20140	22299	10	40	14	16

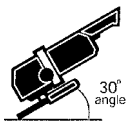

Note: Reusable 5/8-11 adaptor for use on Type 1 and Type 27 reinforced wheels with a 7/8 arbor, a max. diameter of 5" and a wheel thickness of .045 to 1/8" available on page 143 (part #95055)



Also available: Pipeline Brushes page 136



- Designed for both cutting and light grinding, eliminating the need for 2 separate wheels
- All sizes reinforced with the highest quality fiberglass for maximum safety and performance
- **Our unique Super-Lock™ Hub combines both a mechanical locking system and chemical bond providing one of the safest, vibration-free designs in the industry**
- Saitech™, manufactured with patented 3M™ ceramic abrasive grain, is designed to outlast standard aluminum oxide wheels (3M is a trademark of 3M Company)

Blending



Die Grinder



Angle Grinder

COTTON FIBER

COTTON FIBER

COTTON FIBER

A24 UA-MTX

- Aluminum oxide grain
- UA-MTX tough resin combined with coarse grit
- Excellent for light or medium weld removal

STAINLESS Stainless steel

ALUMINUM Non-ferrous metals

METAL Ferrous metals

A36 UA-GFX

- UA-GFX latex bond for weld blending
- Resilient for use on contours, non-loading

STAINLESS Stainless steel

ALUMINUM Non-ferrous metals

METAL Ferrous metals

A54 UA-GFX

- UA-GFX latex bond for weld blending and finishing

STAINLESS Stainless steel

ALUMINUM Non-ferrous metals

METAL Ferrous metals

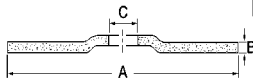

Size			Max RPM	Grades Available			Qty Per Box	Lbs Per Box
A Dia.	B Width	C Bore		A24	A36	A54		
4	1/4	5/8	13,500	-	29201	29202	10	3
4-1/2	1/4	7/8	13,300	29206	29207	29208	10	3
7	1/4	7/8	8,500	29212	29213	29214	10	9

Cotton Fiber Mounted Points

- A54MTX - Resin Bond - light removal/blending
- A80GFX - Latex Bond - finer grit for ultimate finishing

STAINLESS Blending on stainless steel, high tensile alloys

ALUMINUM Non-ferrous metals

METAL Ferrous metals

Type	Size		Shank Dia.	Part No.		"O" = 1/2" Max RPM	Qty Per Box
	Dia.	Length		A54MTX	A80GFX		
A5	3/4	1-1/8	1/4	50560	50360	38,550	10
B42	1/2	3/4	1/4	50561	50361	61,120	10
B52	3/8	3/4	1/4	50562	50362	78,340	10
B121	1/2	1/2	1/4	-	50363	69,310	10
B122	3/8	3/8	1/4	-	50364	69,310	10
W163	1/4	1/2	1/4	-	50365	33,750	10
W189	1/2	2	1/4	50566	50366	26,830	10
W220	1	1	1/4	-	50367	25,500	10
W222	1	2	1/4	-	50368	15,900	10



RA (roughness average) Values

Specification	304 Stainless Steel	6061 Aluminum
A24UA-MTX	140 RA	N/A
A36UA-GFX	40 RA	130 RA
A54UA-GFX	30 RA	80 RA



Quick Tip
These wheels work great on aluminum without clogging or loading.



Mandrel overhang "O" must always be the lowest possible. Maximum speeds given refer to overhang "O" equal to 1/2"

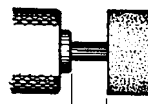

"O" = 1/2"



Tech INFO

- Multiple layers of cotton impregnated with abrasive grain and special bonding agents allow for the coolest blending and finishing wheels
- Special cotton formula will never load on soft non-ferrous metals like aluminum
- Available in two bonding agents for use in many applications



Die Grinder



Portable Grinder

SAIT-LOK-R™ discs are made of multiple layers of cotton fiber abrasive impregnated material. These quick change discs produce a smooth finish in one step.

Finishing discs

A24M

- Aluminum oxide grain
- Coarse grit with medium flexibility for aggressive action

STAINLESS Blending on stainless steel, high tensile alloys

ALUMINUM Non-ferrous metals

METAL Ferrous metals

A36F

- Medium grit with higher flexibility for smoother action

STAINLESS Blending on stainless steel, high tensile alloys

ALUMINUM Non-ferrous metals

METAL Ferrous metals

A54F

- Fine grit with higher flexibility for finishing

STAINLESS Blending on stainless steel, high tensile alloys

ALUMINUM Non-ferrous metals

METAL Ferrous metals

A80F

- Finer grit for ultimate finishing

STAINLESS Blending on stainless steel, high tensile alloys

ALUMINUM Non-ferrous metals

METAL Ferrous metals



Nylon screw threaded hub for easy mounting to the backing pad

See page 145 for backing pad

RA (roughness average) Values

Sait-Lok-R™		
Specification	304 Stainless Steel	6061 Aluminum
A24M	70 RA	90 RA
A36F	40 RA	60 RA
A54F	30 RA	50 RA
A80F	20 RA	45 RA



Deburring wheels

A54GFX/A54MTX

- Fine grit with higher flexibility for finishing

STAINLESS Deburring of stainless steel, high tensile alloys

ALUMINUM Non-ferrous metals

METAL Ferrous metals

Size Dia.	Max RPM	Part Numbers				Qty Per Box	Lbs Per Box
		A24M	A36F	A54F	A80F		
2	30,000	50300	50301	50302	50303	25	1
3	20,000	50308	50309	50310	50311	25	2

Size			Max RPM	Grades Available		Qty Per Box	Lbs Per Box
A Dia.	B Width	C Bore		Part Numbers			
3	1/16	3/8	18,000	-	29310	10	1
3	1/8	3/8	12,000	29312	-	10	1
4	1/8	3/8	9,075	29322	-	10	1



- Multi-layer disc configuration provides longer life than coated abrasive discs
- Cotton fiber abrasive material will not smear on titanium and stainless steel
- Outlasts coated discs 10 to 1 for less downtime and increased productivity

HAND/FLOOR RUBS



Hand Rub

VITRIFIED

VITRIFIED

The vitrified bonding technique uses a high temperature process whereby abrasive materials are heated to a point where the grains fuse to each other, forming the bond posts. Vitrified products, although somewhat brittle, are not affected by water, oil, most acids, or temperature changes. Used primarily for precision and fixed-feed applications, they are particularly well suited for bench grinders and offhand tool room applications.



Hand and Floor Rubs

- Removes form marks

CONCRETE Concrete

- Configurations available:

Plain - For cleaning castings and dressing bench grinding wheels

Fluted - For extra shearing action

Handle - For extra comfort and working overhead

Scored - Breaks into two 4 x 2 x 2 floor rubs

Packaging

Each box of HR202 and FR521 contains 6 wood wedges

Additional wood wedges, see page 146

Type	Size			Description	Grade	Part Number	Qty Per Box	Lbs Per Box
	Length	Width	Height					
HR202	4	2	2	Plain	C24R	25010	6	7
HR241	6	2	2	Fluted	C24R	25020	5	10
HR242	8	2	2	Fluted	C24R	25030	5	12
HR252	6	3	1	Handle	C24R	25040	5	10
HR250	8	3-1/2	1-1/2	Handle	C24R	25050	5	19
FR521	8	2	2	Scored	C10R	25060	3	14
FR521	8	2	2	Scored	C24R	25061	3	14
FR521	8	2	2	Scored	C80R	25062	3	14

Tech
INFO

- Vitrified bond for long life
- Available in several configurations for a wide range of cleaning and dressing applications

BENCH WHEELS



Bench Grinder

VITRIFIED

VITRIFIED

A

- Aluminum oxide grain
- General purpose
- For sharpening tools and light stock removal

METAL Ferrous metals
(carbon steel, steel, iron, forgings, etc.)

GC

- Green silicon carbide grain
- Extremely sharp grain for faster, burr-free cutting
- Use on carbide tipped tools, cast iron

METAL Ferrous and/or non-ferrous metals



Reduction bushings enclosed with each wheel

Wheel Size	Bushings
6"	3/4, 5/8, 1/2
7"	3/4, 5/8, 1/2
8"	3/4, 5/8
10"	1, 3/4
12"	1-1/4, 1
14"	1-1/4, 1

Aluminum Oxide

Size			Max RPM	Grades Available					Lbs Per Box
A Dia.	B Width	C Bore		Part Numbers					
				A24	A36	A46	A60	A80	
6	1/2	1	4,456	-	28003	-	28004	28005	1-1/2
6	3/4	1	4,456	-	28000	-	28001	28002	2
6	1	1	4,456	-	28006	-	28007	28008	2-1/2
7	3/4	1	3,760	-	28010	-	28011	28012	2-1/2
7	1	1	3,760	-	28013	-	28014	28015	3-1/2
8	3/4	1	3,600	-	28020	-	28021	28022	3-1/2
8	1	1	3,600	-	28023	-	28024	28025	4-1/2
10	1	1-1/4	2,674	-	28040	28043	28041	28042	7
10	1-1/2	1-1/4	2,674	-	28050	28053	28051	28052	10
12	2	1-1/2	2,228	28060	28063	28061	28062	-	19-1/2
14	2	1-1/2	1,910	28070	28073	28071	28072	-	28

Green Silicon Carbide

Size			Max RPM	Grades Available			Lbs Per Box
A Dia.	B Width	C Bore		Part Numbers			
				GC60	GC80	GC120	
6	3/4	1	4,456	28100	28101	28102	1-1/2
6	1	1	4,456	28103	28104	28105	2
7	1	1	3,760	28113	28114	28115	2-1/2
8	1	1	3,600	28123	28124	28125	3-1/2
10	1	1-1/4	2,674	28140	28141	28142	6-1/2
12	2	1-1/2	2,228	28160	28161	28162	19-1/2
14	2	1-1/2	1,910	28170	28171	-	28



- Vitrified bond for long life
- Available in two formulations for a wide range of applications
- Individually packaged for safety and convenience



CUTTING

- This section contains Type 27 and Type 1 cut-off wheels.
- These wheels will cut a wide range of materials.
- Some of the categories contain Specialty Wheels that are used for a specific application.
- For example, our Stud King® Chop Saw Wheel is specifically designed to cut metal studding and thin gauge metals.

CUTTING
WHEELS

PRODUCT TYPE	SPECS	PAGES
--------------	-------	-------

Thin High Speed Cut-Off Wheels



A24R
General Purpose
A36T
Long Life
A60T
Burr-free Cutting
Saitech™
Stainless Steel

46-47

.045, .090 & 1/16 High Speed Cut-Off Wheels



A60S
General Purpose
A46N
Aluminum
SAIT.M.X.™
Fast burr-free cutting
SAIT Z-tech™
High Performance

Saitech™
Stainless Steel
The Ultimate Cut™
Best in Class
The Ultimate Ceramic™
Premium
XA46R
Contaminant-Free

36-41



.095 The Ultimate Combo™ Wheels



A60S
General Purpose
Z-Tech™
High Performance

42

3/32 & 1/8







A24R
General Purpose
SAIT Z-tech™
High Performance
Saitech Ultimate Performance™
High Purpose/Stainless Steel
C24R
Concrete
XA24Q
Contaminant-Free

43-45

CUTTING



PRODUCT TYPE	SPECS		PAGES
Portable Saw Cut-Off Wheels 	A24R General Purpose SAIT XFC™ Extremely Fast Cutting SAIT-Pro Metal Brute™ Metal Decking A30S Long Life	Hobo® Rail Steel Ductile™ Ductile Pipe C24R Concrete Big M.A.C.™ Masonry, Asphalt, Concrete	48 52-54
Chop Saw Wheels 	EZ-Chop Attacker® General Purpose EZ-Chop® Burr Free SAIT Z-tech™ High Performance	Stud King® Metal Studding Iron Worker™ Angle Iron Saitech™ Steel Worker® Stainless Aluminum	50-51
Metal-Cutting Carbide Blades 	Steel Worker® TMX - Thin Metal Xtra Stainless Aluminum		58-61
Stationary Saw Cut-Off Wheels 	A24N Fast Cutting A24R General Purpose	A36R Stainless Steel C24R Concrete	56-57
Street Saw Wheels 	C16 Fast Cutting Street Walker™ Asphalt Street Runner™ Asphalt, Green Concrete		55

Cutting .045"

TYPE 27 Depressed Center Wheels

PATENTED!

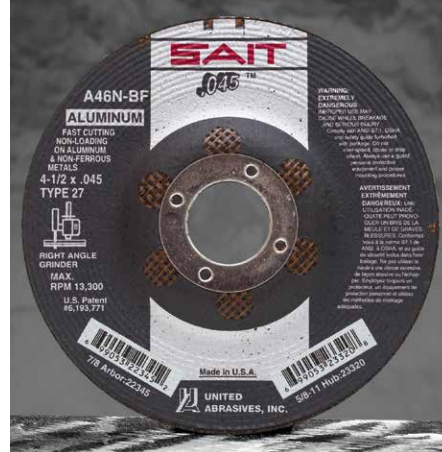

CUTTING WHEELS
GENERAL PURPOSE

A60S - General Purpose

- So unique it has a patent
- Thin .045 width
- Special aluminum oxide grain
- Hard bond for extremely long life
- Fast, burr-free cutting

METAL Ferrous and/or non-ferrous metals (iron, steel, welds, etc.)

A46N - Aluminum (Non-Ferrous Metals)

- Aluminum oxide grain
- Thin .045 width
- Soft bond for aggressive cutting without loading

ALUMINUM Non-ferrous metals (aluminum, copper, brass, etc.)



Z-Tech High Performance

- So unique it has a patent
- Thin .045 width
- Special zirconium grain
- Hard bond for extremely long life
- Fast, burr-free cutting

METAL Ferrous and/or non-ferrous metals (iron, steel, welds, etc.)

STAINLESS Stainless steel, high tensile alloys

QT Quick Tip
Try .045 sizes for longer life and better value.

.045TM

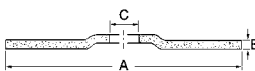

Size			Max RPM	Grades Available			Qty Per Box	Qty Per Ctn	Lbs Per Box
A Dia.	B Width	C Bore		Part Numbers					
4	.045	5/8	19,000	22011	-	-	50	200	4
4-1/2	.045	7/8	13,300	22021	22345	23334	50	200	4
4-1/2	.045	5/8-11	13,300	23318	23320	23322	10	40	2
5	.045	7/8	12,200	22071	22350	23335	50	200	6
5	.045	5/8-11	12,200	23305	23307	23309	10	-	2
6	.045	7/8	10,200	22047	22360	23336	50	200	8
7	.045	7/8	8,500	22053	22370	23337	50	200	14



Tech INFO

- Unique, thin Type 27 shape can be used on all angle grinders in accordance with ANSI B7.1
- Special aluminum oxide formulation offers the fastest cutting, longest lasting thin wheels
- Externally reinforced with fiberglass layers to provide ultimate safety in a thin wheel

TYPE 27 High Performance Wheels

Cutting .045"

PATENTED!



CUTTING
WHEELS

Saitech .045™

- High performance, ceramic aluminum oxide grain
- Very uniform, high density grain structure is extremely durable and self sharpening for long life and cooler cut
- So unique it has a patent
- Thin .045 width
- Fast cutting with long life

STAINLESS Stainless steel, high tensile alloys

METAL Ferrous metals (iron, steel, welds, etc.)

THE ULTIMATE Cut™

The Ultimate Cut™

- Best in class – cutting a wide range of **STAINLESS** thin & thick gauge, flat stock, bar stock, square tubing, etc.
- Exceptional cutting performance on

METAL ALUMINUM

THE ULTIMATE Ceramic CUT-OFF™

The Ultimate Ceramic™

- Premium ceramic aluminum oxide grain
- Exceptionally long-lasting on carbon steel, stainless steel, and hard to grind alloys
- Maximizes productivity

METAL STAINLESS

NEW!

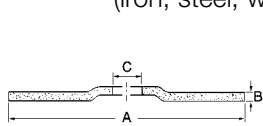

See pages 38-39 for Type 1 .045 wheels

Size			Max RPM	Grades Available			Qty Per Box	Qty Per Ctn	Lbs Per Box
A Dia.	B Width	C Bore		Saitech™	Ult. Cut™	Ult. Ceramic™			
4	.045	5/8	19,000	22068	-	-	50	200	4
4-1/2	.045	7/8	13,300	22072	22380	22470	50	200	4
4-1/2	.045	5/8-11	13,300	23319	23321	22570	10	40	2
5	.045	7/8	12,200	22073	22385	22471	50	200	6
5	.045	5/8-11	12,200	23306	23308	22571	10	-	2
6	.045	7/8	10,200	22082	22390	22472	50	200	8
7	.045	7/8	8,500	22088	-	-	50	200	14



Note: Reusable 5/8-11 adaptor for use on Type 1 and Type 27 reinforced wheels with a 7/8 arbor, a max. diameter of 5" and a wheel thickness of .045 to 1/8" available on page 143 (part #95055)



Angle Grinder



- Saitech™, manufactured with patented 3M™ ceramic abrasive grain, is designed to outlast standard aluminum oxide wheels (3M is a trademark of 3M Company)
- Thin cutting wheel in a Type 27 shape makes this perfect for your angle grinder
- Unique bonding system lets you make faster burr-free cuts
- Designed to provide very long life for fewer wheel changes and less downtime
- All sizes reinforced with the highest quality fiberglass for maximum safety and performance

STAINLESS STEEL/HIGH PERFORMANCE

Cutting **.045"** **TYPE 1** Thin High Speed Cut-Off



A60S General Purpose **.045™**

- Thin .045 width
- Use with reusable 5/8-11 adaptor to fit angle grinders
- **Extremely fast cutting with long life**
- **Exceptional performance**

METAL Ferrous and/or non-ferrous metals (iron, steel, welds, etc.)

StackPack



See page 151 for details



SAIT.M.X.™ (Ferrous Metals)

- Special bond for cutting sheet metal and other thin gauge metals
- **Fast, burr-free cutting**

METAL Ferrous metals (carbon steel, etc.)

STAINLESS Stainless steel



A46N - Aluminum (Non-Ferrous Metals)

- Aluminum oxide grain
- **Soft bond for aggressive cutting without loading**
- Use with reusable 5/8-11 adaptor to fit angle grinders

ALUMINUM Non-ferrous metals (aluminum, copper, brass, etc.)



XA46R contaminant free

- Specially formulated for nuclear and food processing plants
- Free of iron, chlorine and sulphur compounds (Fe + Cl + S < 0.1%)
- All wheels are 1/16" thick

STAINLESS Stainless steel and other high tensile alloys

Note: Reusable 5/8-11 adaptor for use on Type 1 and Type 27 reinforced wheels with a 7/8 arbor, a max. diameter of 5" and a wheel thickness of .045 to 1/8" available on page 143 (part #95055)

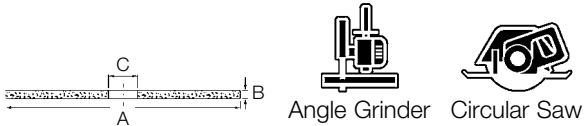

Size			Max RPM	Grades Available			Qty Per Box	Qty Per Ctn	Lbs Per Box
A Dia.	B Width	C Bore		Part Numbers					
4	.045	5/8	19,000	23099	-	-	50	200	4
4-1/2	.045	7/8	13,300	23101	23604	23314	50	200	4
5	.045	7/8	12,200	23103	23605	-	50	200	6
6	.045	5/8	10,200	23105	-	-	50	200	8
6	.045	7/8	10,200	23106	23606	23316	50	200	8
7	.045	5/8	8,500	23107	-	-	50	200	14

Size			Max RPM	Part No.	Qty Per Box	Qty Per Ctn	Lbs Per Box
A Dia.	B Width	C Bore					
4-1/2	1/16	7/8	13,300	24251	50	200	7
5	1/16	7/8	12,200	24252	50	200	7
6	1/16	7/8	10,200	24253	50	200	14
7	1/16	7/8	8,500	24254	50	200	14



- Type 1 shape for square, burr-free cutting
- Special aluminum oxide formulation offers the fastest cutting, longest lasting thin wheels
- Externally reinforced with fiberglass layers to provide ultimate safety in a thin wheel
- Wide range of sizes available to fit both angle grinders and circular saws
- Specially formulated for contaminant-free stock removal on stainless steel (XA46R)

TYPE 1 Thin High Speed Cut-Off

Cutting .045"

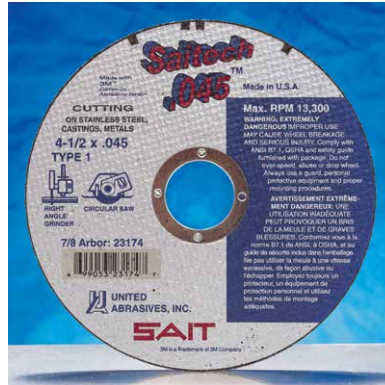

Z-Tech

High Performance

- Special zirconium grain formula
- Fast, non-binding cutting

METAL Ferrous metals

STAINLESS Stainless steel, high tensile alloys

- High performance, ceramic aluminum oxide grain
- Very uniform, high density grain structure is extremely durable and self sharpening for long life and cooler cut
- Fast cutting with extremely long life

STAINLESS Stainless steel, high tensile alloys

METAL Ferrous and/or non-ferrous metals

The Ultimate Cut™

- Best in class – cutting a wide range of **STAINLESS** thin & thick gauge, flat stock, bar stock, square tubing, etc.
- Exceptional cutting performance on

METAL ALUMINUM



The Ultimate Ceramic™

- Premium ceramic aluminum oxide grain
- Exceptionally long-lasting on carbon steel, stainless steel, and hard to grind alloys
- Maximizes productivity

METAL STAINLESS



Angle Grinder Circular Saw

Note: Reusable 5/8-11 adaptor for use on Type 1 and Type 27 reinforced wheels with a 7/8 arbor, a max. diameter of 5" and a wheel thickness of .045 to 1/8" available on page 143 (part #95055)

See pages 36-37 for Type 27 depressed center .045 cutting wheels.

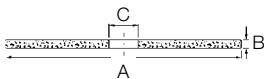

Size			Max RPM	Grades Available				Qty Per Box	Qty Per Ctn	Lbs Per Box
A Dia.	B Width	C Bore		Ult. Ceramic™	Z-Tech™	Saittech™	Ult. Cut™			
4	.045	5/8	19,000	-	23323	23172	-	50	200	4
4-1/2	.045	7/8	13,300	22480	23324	23174	22230	50	200	4
5	.045	7/8	12,200	22481	23325	23177	22235	50	200	6
6	.045	5/8	10,200	-	-	23181	-	50	200	8
6	.045	7/8	10,200	22482	23327	23182	22240	50	200	8
7	.045	5/8	8,500	-	23328	23184	-	50	200	14



- Type 1 shape for square, burr-free cutting
- Saittech™, manufactured with patented 3M™ ceramic abrasive grain, is designed to outlast standard aluminum oxide wheels (3M is a trademark of 3M Company)
- Externally reinforced with fiberglass layers to provide ultimate safety in a thin wheel
- Wide range of sizes available to fit both angle grinders and circular saws

Cutting

.090"

TYPE 27 Depressed Center Wheels

PATENTED!

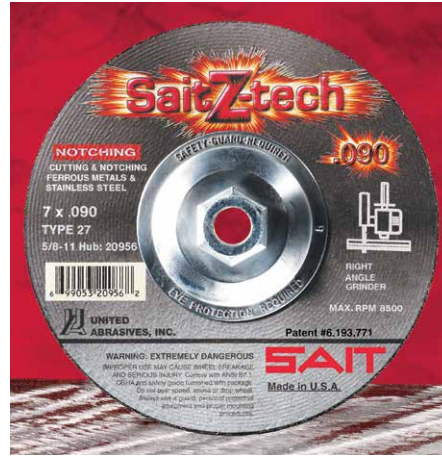

CUTTING WHEELS
SPECIALTY

A60S

General Purpose

- Thin .090 width
- Special aluminum oxide grain
- Hard bond for extremely long life
- Excellent for notching and cutting

METAL Ferrous and/or non-ferrous metals (iron, steel, welds, etc.)

Z-tech

Z-Tech High Performance

- Tough zirconium grain
- High performance cutting and notching for the toughest applications

METAL Ferrous metals (iron, steel, welds, etc.)

STAINLESS Stainless steel, high tensile alloys

Saitech

Ultimate Performance™

- High performance, ceramic aluminum oxide grain
- Very uniform, high density grain structure is extremely durable and self sharpening for long life and cooler cut
- Combines fast cutting with extremely long life for tough cutting applications
- Ideal for foundry applications (gates, risers)

STAINLESS Stainless steel, high tensile alloys

METAL Ferrous metals (iron, steel, welds, etc.)

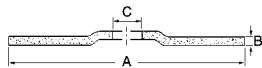

Size			Max RPM	Grades Available			Qty Per Box	Qty Per Ctn	Lbs Per Box
A Dia.	B Width	C Bore		Part Numbers					
				A60S	Z-tech™	Saitech™			
4-1/2	.090	7/8	13,300	20903	20943	20923	25	100	4
4-1/2	.090	5/8-11	13,300	20913	20953	20933	10	40	5
5	.090	7/8	12,200	20904	20944	-	25	100	6
5	.090	5/8-11	12,200	20914	20954	-	10	40	5
6	.090	7/8	10,200	20905	20945	-	25	100	8
6	.090	5/8-11	10,200	20915	20955	-	10	40	7
7	.090	7/8	8,500	20906	20946	-	25	100	14
7	.090	5/8-11	8,500	20916	20956	-	10	40	11
9	.090	7/8	6,600	20909	-	-	25	50	21
9	.090	5/8-11	6,600	20919	-	-	10	40	11



5/8-11 Hub



Angle Grinder

Note: Reusable 5/8-11 adaptor for use on Type 1 and Type 27 reinforced wheels with a 7/8 arbor, a max. diameter of 5" and a wheel thickness of .045 to 1/8" available on page 143 (part #95055)

Tech INFO

- Unique, thin Type 27 shape can be used on all angle grinders in accordance with ANSI B7.1
- Special bond formulation offers the fastest cutting, longest lasting thin wheels
- Externally reinforced with fiberglass layers to provide ultimate safety in a thin wheel
- Saitech™, manufactured with patented 3M™ ceramic abrasive grain, is designed to outlast standard aluminum oxide wheels (3M is a trademark of 3M Company)

TYPE 1 High Speed Cut-Off Wheels

Cutting .090"

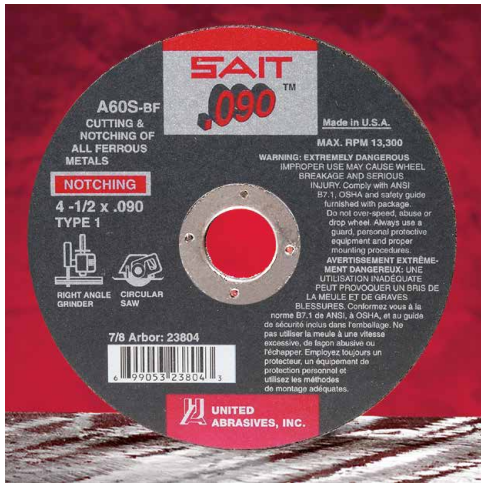

.090™

A60S - General Purpose

- Aluminum oxide grain
- Provides consistent performance with long life

METAL Ferrous metals
(steel, angle iron, rebar)



Sait Z-tech™

Z-tech High Performance

- Tough zirconium grain
- High performance cutting and notching for the toughest applications

METAL Ferrous metals
(iron, steel, welds)

STAINLESS Stainless steel,
high tensile alloys

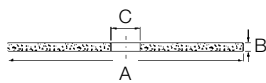

Size			Max RPM	Grades Available		Qty Per Box	Qty Per Ctn	Lbs Per Box
A Dia.	B Width	C Bore		Part Numbers				
4-1/2	.090	7/8	13,300	23804	23824	25	100	4
5	.090	7/8	12,200	-	23825	25	100	6
6	.090	7/8	10,200	23806	23826	25	100	8
7	.090	5/8	8,500	23807	23827	25	50	14



Circular Saw



Angle Grinder



- Type 1 shape for square, burr-free cutting
- Externally reinforced with the highest quality fiberglass to withstand the toughest applications
- Available in multiple arbor sizes to fit a wide variety of tools

CUTTING
WHEELS

SPECIALTY

Combo

TYPE 27

.095" Cut, Notch, Deburr, & Light Grind

4 APPLICATIONS WITH JUST 1 WHEEL

Less Wheel Changes = Greater Productivity

CUTTING WHEELS

COMBO

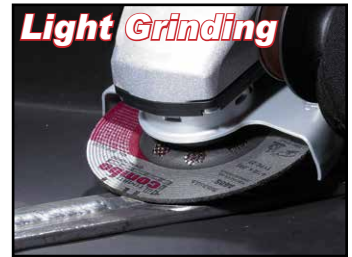

1 in 1 THE ULTIMATE™ combo
CUT - NOTCH - DEBUR - LIGHT GRIND

A60S - General Purpose

- Aluminum oxide grain
- Provides consistent performance with long life for cutting, notching, deburring, & light grinding

METAL Ferrous metals (steel, angle iron, rebar)

Now Available in 6"



Z-Tech High Performance

- Tough zirconium grain
- High performance cutting, notching, deburring, and light grinding for the toughest applications

METAL Ferrous metals (iron, steel, welds)

STAINLESS Stainless steel, high tensile alloys

.095"
4 Applications
1 Wheel!

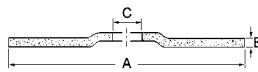

Size			Max RPM	Grades Available		Qty Per Box	Qty Per Ctn	Lbs Per Box
A Dia.	B Width	C Bore		Part Numbers				
4-1/2	.095	7/8	13,300	22320	22330	25	100	3
4-1/2	.095	5/8-11	13,300	22420	22430	10	40	4
5	.095	7/8	12,200	22325	22335	25	100	4
6	.095	7/8	10,200	22326	22336	25	100	8
6	.095	5/8-11	10,200	22426	22436	10	40	7



NEW 6"

Tech INFO

- Increases Productivity: 1 wheel to cut, notch, deburr, and light grind
- 2 formulas for a wide variety of production applications and maintenance work.
- Additional reinforcement for added strength and versatility

TYPE 27 Specialty Cutting Wheels

Cutting 3/32"



A24R - General Purpose

- Aluminum oxide grain
- For general purpose use
- Combines fast cutting and long life

METAL Ferrous metals (iron, steel, welds, etc.)

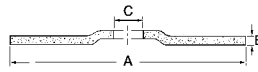

Size			Max RPM	Part Number	Qty Per Box	Qty Per Ctn	Lbs Per Box
A Dia.	B Width	C Bore					
3	1/8	3/8	18,000	22000	25	100	2
4	1/8	3/8	13,500	22010	25	100	3
4-1/2	3/32	7/8	13,300	22020	25	100	5
4-1/2	3/32	5/8-11	13,300	22120	10	40	7
5	3/32	7/8	12,200	22070	25	100	6
5	3/32	5/8-11	12,200	22170	10	40	7
6	1/8	7/8	10,200	22045	25	100	25
7	3/32	7/8	8,500	22056	25	100	14
7	3/32	5/8-11	8,500	22057	10	40	9
9	3/32	7/8	6,600	22066	25	50	22
9	3/32	5/8-11	6,600	22067	10	40	12



Angle Grinder



Z24R - Zirconium

- Tough zirconium grain
- High performance cutting for the toughest applications

METAL Ferrous metals (iron, steel, welds)

STAINLESS Stainless steel, high tensile alloys

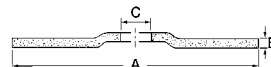

Size			Max RPM	Part Number	Qty Per Box	Qty Per Ctn	Lbs Per Box
A Dia.	B Width	C Bore					
4-1/2	3/32	7/8	13,300	22641	25	100	7
4-1/2	3/32	5/8-11	13,300	22651	10	40	5
6	3/32	7/8	10,200	22644	25	25	10
6	3/32	5/8-11	10,200	22654	10	40	7



- Aggressive cutting performance over a wide range of applications
- Our unique Super-Lock™ Hub combines both a mechanical locking system and chemical bond providing one of the safest, vibration-free designs in the industry
- All sizes reinforced with the highest quality fiberglass for maximum safety and performance

CUTTING
WHEELS

SPECIALTY

Saitech Cutting

3/32" Saitech High Performance Wheels

TYPE 27

CUTTING WHEELS

STAINLESS STEEL



Saitech Ultimate Performance™

- High performance, ceramic aluminum oxide grain
- Very uniform, high density grain structure is extremely durable and self sharpening for long life and cooler cut
- Combines fast cutting with extremely long life for tough cutting applications
- Ideal for foundry applications (gates, risers)

STAINLESS Stainless steel, high tensile alloys

METAL Ferrous metals (iron, steel, welds, etc.)

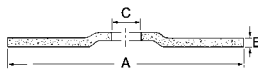

Size			Max RPM	Part Number	Qty Per Box	Qty Per Ctn	Lbs Per Box
A Dia.	B Width	C Bore					
4-1/2	3/32	7/8	13,300	22064	25	100	7
4-1/2	3/32	5/8-11	13,300	22069	10	40	5
5	3/32	7/8	12,200	22074	25	100	7
5	3/32	5/8-11	12,200	22079	10	40	5
7	3/32	7/8	8,500	22084	25	100	13
7	3/32	5/8-11	8,500	22089	10	40	10
9	3/32	7/8	6,600	22094	25	50	21
9	3/32	5/8-11	6,600	22099	10	40	11



Tech INFO

- Saitech™, manufactured with patented 3M™ ceramic abrasive grain, is designed to outlast standard aluminum oxide wheels (3M is a trademark of 3M Company)
- Unique bonding system lets you make faster burr-free cuts
- Designed to provide very long life for fewer wheel changes and less downtime
- Our unique Super-Lock™ Hub combines both a mechanical locking system and chemical bond providing one of the safest, vibration-free designs in the industry

TYPE 27 Depressed Center Wheels

Cutting
1/8"



C24R - Concrete

- Silicon carbide grain
- General purpose cutting, hard bond for long life

CONCRETE Masonry, concrete, stone

METAL Cast iron and other ferrous metals

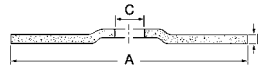

Size			Max RPM	Part Number	Qty Per Box	Qty Per Ctn	Lbs Per Box
A Dia.	B Width	C Bore					
4-1/2	3/32	7/8	13,300	22025	25	100	5
4-1/2	3/32	5/8-11	13,300	22125	10	40	7

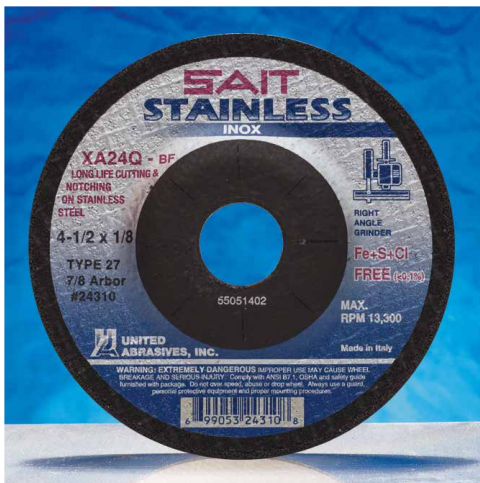

XA24Q - Contaminant-Free

- Specially formulated for nuclear and food processing plants
- Free of iron, chlorine and sulphur compounds (Fe + Cl + S < 0.1%)

STAINLESS Stainless steel and other high tensile alloys

METAL Ferrous metals (iron, steel, welds, etc.)

contaminant **cf** free

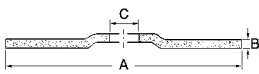

Size			Max RPM	Part Number	Qty Per Box	Qty Per Ctn	Lbs Per Box
A Dia.	B Width	C Bore					
4-1/2	1/8	7/8	13,300	24310	25	100	5
5	1/8	7/8	12,200	24315	25	100	5
6	1/8	7/8	10,200	24320	25	100	8
7	1/8	7/8	8,500	24325	25	50	13
9	1/8	7/8	6,600	24330	25	50	20



Angle Grinder



- Special silicon carbide grain formula is excellent for cutting masonry, concrete, stone, and aggregate (C24R)
- All sizes reinforced with the highest quality fiberglass for maximum safety and performance
- Our unique Super-Lock™ Hub combines both a mechanical locking system and chemical bond providing one of the safest, vibration-free designs in the industry
- Specially formulated for contaminant-free stock removal on stainless steel (XA24Q)

CUTTING
WHEELS

STAINLESS STEEL/CONCRETE

Cutting



Die Grinder

TYPE 1

Thin High Speed Cut-off Wheels

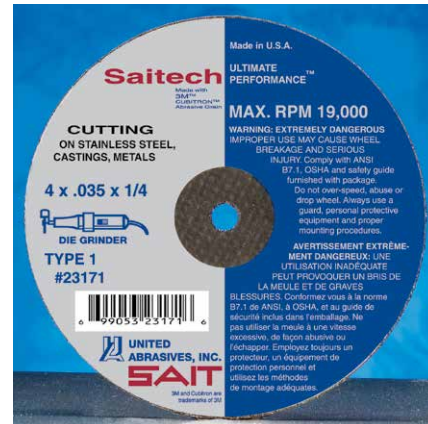
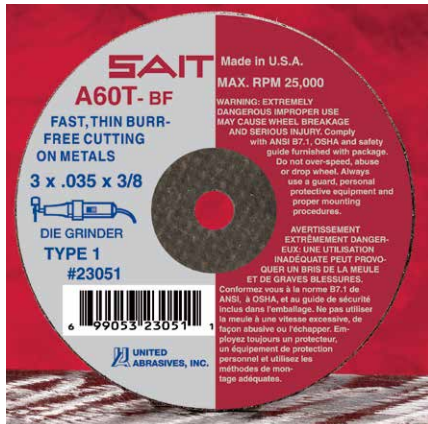

CUTTING WHEELS

STAINLESS STEEL/METAL

A24R - General Purpose

- Aluminum oxide grain
- General purpose, long life

METAL Ferrous metals (iron, steel, welds, etc.)

A36T - Fast Cutting

- Aluminum oxide grain
- Hard bond for aggressive cutting on rough applications

METAL Ferrous metals (iron, steel, welds, etc.)

STAINLESS Stainless steel

A60T - Burr Free

- Hard bond for smooth cutting
- For use in nuclear, aerospace, automotive, foundry industries, and plant maintenance

METAL Ferrous metals (iron, steel, welds, etc.)

STAINLESS High tensile metals

Saitech Ultimate Performance™

- High performance, ceramic aluminum oxide grain
- Very uniform, high density grain structure is extremely durable and self sharpening for long life and cooler cut
- High Performance
- Combines fast cutting with extremely long life

STAINLESS Stainless steel, high tensile alloys

METAL Ferrous and/or non-ferrous metals

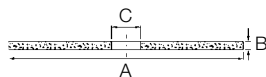

1/4" shank adaptors for wheels up to 3" diameter available on page 143

A Dia.	Size		Max RPM	Grades Available Part Numbers				Qty Per Box	Qty Per Ctn	Lbs Per Box
	B Width	C Bore		A24R	A36T	A60T	Saitech™			
2	1/16	1/4	30,558	-	23004	23005	-	50	50	1
2	1/16	3/8	30,558	-	23002	23003	-	50	50	1
2	.035	1/4	30,558	-	23012	23013	-	100	100	1
2	.035	3/8	30,558	-	23010	23011	-	100	100	1
2-1/2	1/16	1/4	24,446	-	23022	23023	-	50	50	2
2-1/2	1/16	3/8	24,446	-	23020	23021	-	50	50	2
2-1/2	.035	1/4	24,446	-	23032	23033	-	100	100	2
2-1/2	.035	3/8	24,446	-	23030	23031	-	100	100	2
3	1/16	1/4	25,000	-	23042	23043	23142	50	50	3
3	1/16	3/8	25,000	-	23040	23041	23140	50	50	3
3	.035	1/4	25,000	-	23052	23053	23152	100	100	3
3	.035	3/8	25,000	-	23050	23051	23150	100	100	3
3	1/8	3/8	20,372	23060	-	-	-	25	100	2
4	1/16	1/4	19,000	-	23067	23068	23167	50	50	5
4	1/16	3/8	19,000	-	23065	23066	23165	50	50	5
4	1/16	5/8	19,000	-	23061	23062	23161	50	50	5
4	.035	1/4	19,000	-	23071	23072	23171	100	100	5
4	.035	3/8	19,000	-	23069	23070	23169	100	100	5
4	.035	5/8	19,000	-	23063	23064	23163	100	100	5
4	1/8	3/8	15,278	23075	-	-	-	25	100	4



- Type 1 shape for square, burr-free cutting
- Saitch™, manufactured with patented 3M™ ceramic abrasive grain, is designed to outlast standard aluminum oxide wheels (3M is a trademark of 3M Company)
- Externally reinforced with fiberglass layers to provide ultimate safety in a thin wheel

Tool Room Reinforced Cut-off Wheels

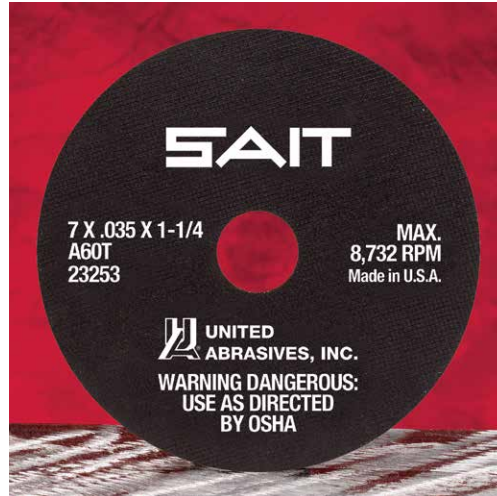

CUTTING
WHEELS

GENERAL PURPOSE

A36T - Fast Cutting

- Aluminum oxide grain
- Hard bond for aggressive cutting on rough applications

METAL Ferrous metals
(iron, steel, welds, etc.)

STAINLESS Stainless steel

A60T - Burr Free

- Hard bond for smooth cutting
- For use in nuclear, aerospace, automotive, foundry industries, and plant maintenance

METAL Ferrous metals
(iron, steel, welds, etc.)

STAINLESS High tensile metals

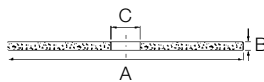

Size			Max RPM	Grades Available Part Numbers		Qty Per Box	Qty Per Ctn	Lbs Per Box
A Dia.	B Width	C Bore		A36T	A60T			
6	1/16	1/2	10,186	23202	-	50	50	8
6	1/16	5/8	10,186	23200	-	50	50	8
6	.035	7/8	10,186	23210	23211	50	50	5
7*	1/16	1-1/4	8,732	23250	23251	50	50	12
7	1/16	5/8	8,732	23265	23266	50	50	6
7*	.035	1-1/4	8,732	23252	23253	50	50	4
8	1/16	5/8	7,640	-	23276	50	50	7



- Type 1 shape for square, burr-free cutting
- Externally reinforced with fiberglass layers to provide ultimate safety in a thin wheel
- Wide range of grit sizes available for aggressive action to burr-free cutting

* These sizes are typically used for tool room applications

Cutting



Circular Saw



Angle Grinder

TYPE 1 Portable Saw Cut-off Wheels

A24R - General Purpose

- Aluminum oxide grain
- Provides consistent performance with **long life**

METAL Ferrous metals (steel, angle iron, rebar)

A30S - Long Life

- Special aluminum oxide grain formula
- **Fast, non-binding cutting**

METAL Ferrous metals

STAINLESS Stainless steel, high tensile alloys

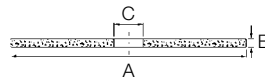

Size			Max RPM	Grades Available		Qty Per Box	Qty Per Ctn	Lbs Per Box
A Dia.	B Width	C Bore		Part Numbers				
4-1/2	5/64	7/8	13,300	-	23102	50	200	9
4-1/2	3/32	7/8	13,300	23100	-	50	200	10
7	3/32	Dia. (5/8)	8,500	23234	-	25	50	10
8	3/32	Dia. (5/8)	7,600	23258	-	25	50	13

C24R - Concrete

- Silicon carbide grain
- **Long life**

CONCRETE Stone, brick, soft aggregate, masonry, concrete

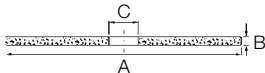

Size			Max RPM	Part Number	Qty Per Box	Qty Per Ctn	Lbs Per Box
A Dia.	B Width	C Bore					
7	3/32	Dia (5/8)	8,500	23235	25	50	9



- Type 1 shape for square, burr-free cutting
- External fiberglass reinforcement withstands offhand lateral pressure for added safety and controlled performance
- Versatile Dia. (5/8) arbor contains diamond knockout for use on circular saw or worm drive saw

CUTTING WHEELS

METAL/CONCRETE

Large Diameter Cutting Wheels & Metal-Cutting Blades

Chop Saw Wheels
pg 50-51



Portable Saw Wheels
pg 48, 52-54

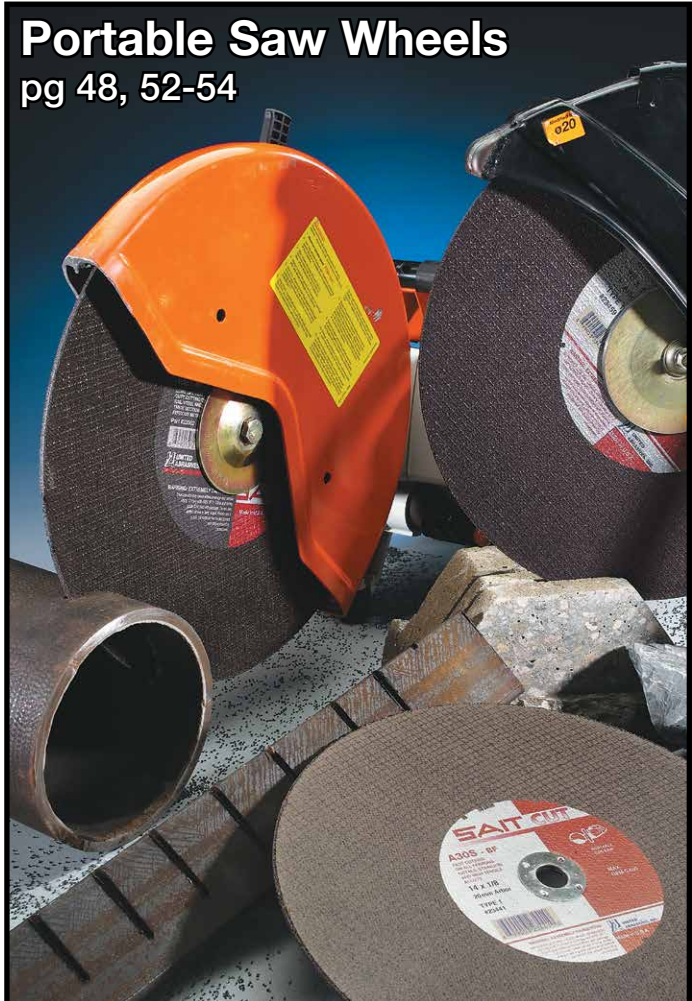

Stationary Saw Wheels
pg 56-57



Metal-Cutting Carbide Blades
pg 58-61



CUTTING
WHEELS

Cutting



TYPE 1 Chop Saw Wheels

CUTTING
WHEELS

GENERAL PURPOSE



SAIT EZ-Chop Attacker®

- Aluminum oxide grain
- General purpose economy cutting
- **Fast cutting on thin metals**

METAL Metal studding, thin rebar, light gauge and medium metals

QT Quick Tip

Use this wheel as an economical alternative for general purpose cutting.



SAIT EZ-Chop®

- Aluminum oxide grain
- General purpose cool cutting on thin metals
- **Burr-free finish**

METAL Metal studding, thin rebar, light gauge and heavy metals

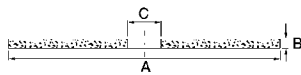

Size			Max RPM	Part Numbers		Qty Per Box	Qty Per Ctn	Lbs Per Box
A Dia.	B Width	C Bore		EZ-Chop Attacker®	EZ-Chop®			
12	3/32	1	5,100	-	24034	10	50	11
14	3/32	1	4,400	24500	24039	10	20	16



- EZ-ChopAttacker® is the most economical general purpose chop saw blade
- Specially formulated ultrathin design for fast cutting of thin gauge metals and heavy metals
- EZ-Chop® is externally reinforced with the highest quality fiberglass to withstand the toughest applications

TYPE 1 Chop Saw Wheels

Cutting



Chop Saw



TM

Z-tech - High Performance

- Special zirconium grain formula
- **Fast, non-binding cutting**

METAL Ferrous metals

STAINLESS Stainless steel, high tensile alloys

Stud King®

- Aluminum oxide grain
- General purpose cool cutting on thin metals
- **Burr-free finish**

METAL Metal studding, thin rebar, light gauge metals

Iron Worker™

- Aluminum oxide grain
- **Fast cutting**
- Excellent for use on angle iron, channel iron, heavy rebar, and other ferrous metals

METAL Structural metal applications

Saitech Steel Worker®

- Formulated with 3M™ ceramic abrasive grain
- Extremely fast, burr-free cutting

STAINLESS Stainless steel, high tensile alloys

METAL Ferrous metals (steel, iron, welds, etc.)

Non-Ferrous Metals (Aluminum)

- Aluminum oxide grain
- Special **non-loading formulation**

METAL Non-ferrous metals (aluminum, bronze, brass, etc.)



Quick Tip

Use the Steel Worker® for fast, cool cutting on stainless steel.

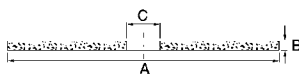

Size			Max RPM	Grades Available					Qty Per Box	Qty Per Ctn	Lbs Per Box
A Dia.	B Width	C Bore		Part Numbers							
				Z-Tech™	S.K.	I.W.	Saitech™	Alum.			
10	3/32	5/8	6,100	-	24035	-	-	-	25	50	20
12	3/32	1	5,100	-	24030	24031	24033	-	10	50	11
14	3/32	1	4,400	24414	24050	24051	24053	24052	10	20	16
16	3/32	1	3,700	-	24010	24011	24013	-	10	20	23



- Specially formulated for use on low horsepower chop saw machines for fast cutting with minimal pressure
- Five specialty formulas give you the exact wheel for your cutting application
- 14" Z-tech is internally reinforced with the highest quality fiberglass to withstand the toughest applications
- Saitech™, manufactured with patented 3M™ ceramic abrasive grain, is designed to outlast standard aluminum oxide wheels (3M is a trademark of 3M Company)

CUTTING
WHEELS

HIGH PERFORMANCE/SPECIALTY



Portable Saw

Portable Saw Cut-off Wheels



A24R - General Purpose/Durability

- Special aluminum oxide grain
- Provides consistent performance with long life

METAL Ferrous metals (steel, angle iron, rebar)

XFC™ - Extremely Fast Cutting

- Special aluminum oxide grain formula
- Fast cutting action
- Non-binding cutting formula

METAL Ferrous metals

STAINLESS Stainless steel, high tensile alloys



SAIT Pro - Metal

- Aluminum oxide grain
- Best value for a fast cut

METAL Ferrous metals

CUTTING WHEELS

GENERAL PURPOSE

2 Wheels in 1!

14" and 16" portable wheels are formulated to interchange between high and low power saws!

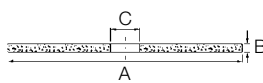

Size			Max RPM	Grades Available			Qty Per Box	Qty Per Ctn	Lbs Per Box
A Dia.	B Width	C Bore		Part Numbers					
				A24R	XFC™	SAIT Pro			
12	1/8	1	6,300	23410	-	23414	10	50	13
12	1/8	20mm	6,300	23420	-	23421	10	50	14
14	1/8	1	5,400	23450	24150	24135	10	20	19
14	1/8	20mm	5,460	23455	24160	24140	10	20	24
16	1/8	1	4,800	23459	-	-	10	20	30

14" (20mm) with higher RPM rating for STIHL saws



- Type 1 shape for square, burr-free cutting
- Externally reinforced with the highest quality fiberglass to withstand the toughest applications
- Available in multiple arbor sizes to fit a wide variety of tools
- More fiberglass reinforcement than competitors for increased torque strength

TYPE 1

Portable Saw Cut-off Wheels

Cutting



Portable Saw

Brute™

- Long life
- Extremely hard bond for cutting metals that present a very sharp edge to the wheel

METAL Thin metal, sheet metal, decking, other ferrous metals

HOBO®

- For use on high horsepower machines
- Rugged fiberglass reinforcement for maximum safety
- Excellent for the railroad industry

METAL Mainline, secondary, spur rail steel
Also for use on heavy sections of ferrous metals (I-beams, bar stock, etc.)



Ductile™

- Combination aluminum oxide and silicon carbide formulation

METAL Ductile pipe (very hard steel casing enclosing a cement lining), water mains, etc.

CONCRETE Combination metal/concrete, cast iron, hard metals, concrete coated steel, etc.

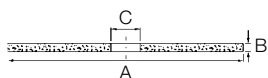

Size			Max RPM	Part Number	Qty Per Box	Qty Per Ctn	Lbs Per Box
A Dia.	B Width	C Bore					
Brute™							
12	1/8	1	6,300	23412	10	50	15
12	1/8	20mm	6,300	23422	10	50	14
14	1/8	1	5,400	23452	10	20	22
14	1/8	20mm	5,460	23457	10	20	18
HOBO®							
14	1/8	1	5,400	23501	10	20	22
16	1/8	1	4,800	23502	10	20	30
Ductile™							
12	1/8	1	6,300	23415	10	50	15
12	1/8	20mm	6,300	23425	10	50	15
14	1/8	1	5,400	23453	10	20	22
14	1/8	20mm	5,460	23458	10	20	22
16	1/8	1	4,800	23480	10	20	30



Quick Tip

Use the Ductile™ wheel for extra hard metals, hydraulic hose and PVC pipe.

2 Wheels in 1!

14" and 16" portable wheels are formulated to interchange between high and low power saws!

14" (20mm) with higher RPM rating for STIHL saws



- Type 1 shape for square, burr-free cutting
- Externally reinforced with the highest quality fiberglass to withstand the toughest applications
- Available in multiple arbor sizes to fit a wide variety of tools
- More fiberglass reinforcement than competitors for increased torque strength



CUTTING WHEELS
CONCRETE



C24R - Concrete

- Silicon carbide grain
- Long life

CONCRETE Stone, brick, soft aggregate, masonry, concrete, schedule 40 and schedule 80 PVC pipe



BIG M.A.C.™ - Very Long Life

- Special silicon carbide grain
- Superior cutting action
- 40% longer life than general purpose concrete wheels

CONCRETE Masonry, Asphalt, Concrete

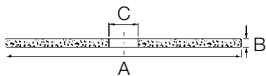

Size			Max RPM	Part Number	Qty Per Box	Qty Per Ctn	Lbs Per Box
A Dia.	B Width	C Bore					
12	1/8	1	6,300	23413	10	50	12
12	1/8	20mm	6,300	23423	10	50	12
14	1/8	1	5,400	23451	10	20	16
14	1/8	20mm	5,460	23456	10	20	15
16	1/8	1	4,800	23461	10	20	30

BIG M.A.C.™

12	1/8	1	6,300	23460	10	50	14
12	1/8	20mm	6,300	23462	10	50	14
14	1/8	1	5,400	23463	10	20	18
14	1/8	20mm	5,460	23464	10	20	18

2 Wheels in 1!
14" and 16" portable wheels are formulated to interchange between high and low power saws!

14" (20mm) with higher RPM rating for STIHL saws



- External fiberglass reinforcement withstands offhand lateral pressure for added safety and controlled performance
- Special silicon carbide grain formula provides excellent cutting action on masonry, concrete, stone and aggregate
- More fiberglass reinforcement than competitors for increased torque strength

TYPE 1 Street Saw Wheels

Cutting



Street Saw



CUTTING
WHEELS

CONCRETE

C16

- Silicon carbide grain
- **Fast, free cutting**

CONCRETE Green concrete, asphalt

Street Walker™

- Silicon carbide grain
- **Hot pressed wheel**
- Combines **fast cutting with long life**

CONCRETE Concrete, green concrete, asphalt

Street Runner™

- Silicon carbide grain
- **Hot pressed wheel**
- Extremely dense wheel with coarse grain
- **Combines fast cutting with extra-long life**

CONCRETE Green concrete and asphalt

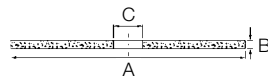

Size			Max RPM	Grades Available			Qty Per Box	Qty Per Ctn	Lbs Per Box
A Dia.	B Width	C Bore		Part Number					
				C16	S.W.	S.R.			
14	3/16	1	4,400	24061	-	-	5	10	12
14	3/16	1	4,365	-	24120	-	10	50	27
14	1/4	1	4,365	-	24121	-	10	50	36
18	1/4	1	3,000	-	-	24145	5	25	35

All wheels have a pinhole



- All wheels have a pinhole for mounting on various machines, street saws, etc.
- These wheels can be used with cooling sprays for dust-free cutting needs
- The Street Walker™ blade is an excellent economical alternative to cutting with diamond blades



CUTTING WHEELS

GENERAL PURPOSE



A24N - Fast Cutting

- Aluminum oxide grain
- General purpose
- Soft bond for fast stock removal

METAL Ferrous metals (iron, cast iron, etc.)

STAINLESS Low grade stainless steel

A24R - Long Life

- Aluminum oxide grain
- General purpose, long life

METAL Ferrous metals (iron, steel, angle iron, etc.)

A36R - Burr-Free

- Aluminum oxide grain
- A finer grit for burr-free finish

METAL Ferrous metals (metal tubing, etc.)

STAINLESS Stainless steel, high tensile steel

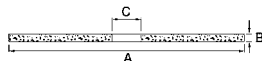

Size			Max RPM	Grades Available			Qty Per Box	Qty Per Ctn	Lbs Per Box
A Dia.	B Width	C Bore		Part Numbers					
10	1/8	5/8	6,100	-	-	24002	25	50	23
12	1/8	1	5,100	-	24020	-	10	50	14
14	1/8	1	4,400	-	24040	-	10	20	19
16	5/32	1	3,800	-	24070	-	10	20	29
18	3/16	1	3,400	24081	24080	24082	5	20	22
20	3/16	1	3,000	24091	24090	24092	5	20	27
24	1/4	1	3,150	24101	24100	24102	5	15	49



- Type 1 shape for square, burr-free cutting
- Maximum grain exposure to cut through large diameter solid stock
- Internal fiberglass reinforcement for maximum safety and controlled performance
- Dual external mounting area reinforcement on 14" - 24" wheels

TYPE 1

Stationary Saw Cut-off Wheels

Cutting



Stationary Saw

C24R - Concrete

- Silicon carbide grain
- General purpose, long life
- Square cutting

CONCRETE Masonry, concrete, stone, brick



CUTTING WHEELS

CONCRETE

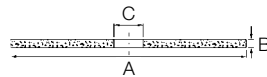

Size			Max RPM	Part Number	Qty Per Box	Qty Per Ctn	Lbs Per Box
A Dia.	B Width	C Bore					
10	1/8	5/8	6,100	24003	25	50	23
18	3/16	1	3,400	24083	5	20	22



- Special grain to fiberglass ratio provides added safety and excellent cutting performance on heavy-duty stationary saws
- Cutting wheels are balanced to provide straight, even cuts for alignment and aesthetics

METAL-CUTTING CARBIDE BLADES



Low RPM Metal
Cutting Saw

Long Life

Cool Cutting

Fast, Burr-Free Cutting

KEY FEATURES

- Designed for use on professional metal-cutting saws
- Premium micro grain carbide: Smaller grains mean more carbide per tooth – stays sharp and provides longer life over competitive blades
- Cuts cool and fast
- Reduced fire hazards and less dust: Metal blades cut cleanly with minimal sparks

Metal-Cutting Carbide Blades

Technical Data

CARBIDE GRAIN STRUCTURE

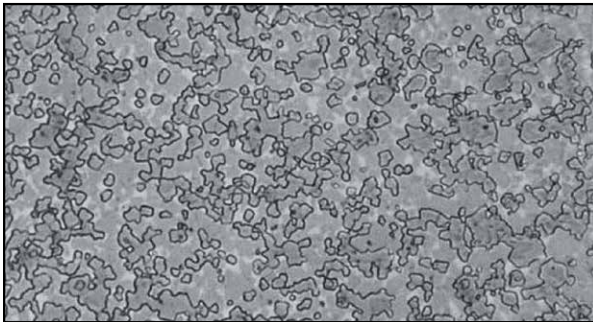

SAIT Carbide Matrix

Consistent size of carbide grains.
More carbide per tooth as grains are smaller.
Smaller grain = harder tooth, more durability.

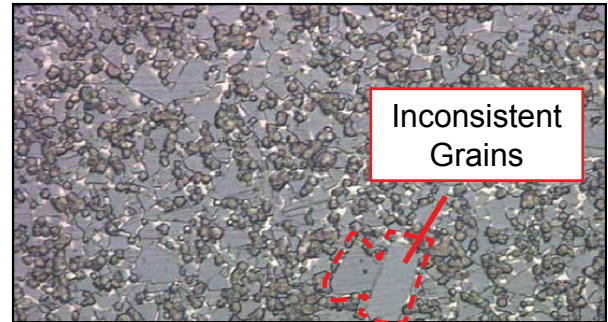

Competitor Carbide Matrix

Very inconsistent size of carbide grains.
Less life due to larger grain sizes.

TOOTH CONFIGURATION

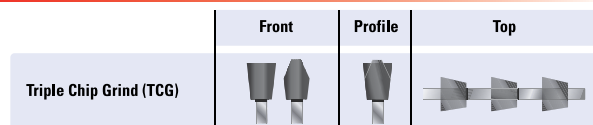

Triple Chip Grind (TCG):

- **FEATURE:** Maximizes blade life by reducing the size of the metal chips that are produced during the cutting operations. Also provides maximum tooth strength for longer life.
- **BENEFIT:** Cleaner and cooler cuts and less stress on material being cut.
- **WHERE USED:** Steelworker® (all sizes), 7-1/4" Stainless, 8", 10" and 12" Aluminum blades

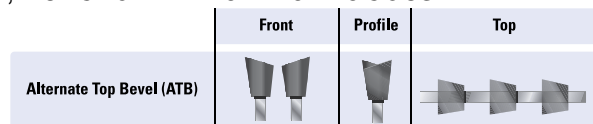

Alternate Top Bevel (ATB)

- **FEATURE:** A multi-purpose grind that allows for durable, long life as well as productive work across a wide range of materials.
- **BENEFIT:** Clean, easy cutting without binding in the material.
- **WHERE USED:** 6-1/2" and 7-1/4" TMX, and 14" Aluminum Blades

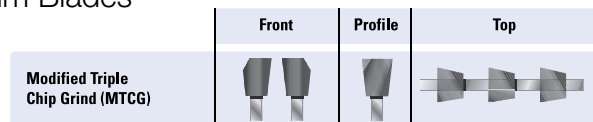

Modified Triple Chip Grind (MTCG):

- **FEATURE:** Excels at reducing chip size for more effective cutting of material. Also improves cutting tooth durability.
- **BENEFIT:** Lower heat build-up and less blade stress while cutting.
- **WHERE USED:** 12" and 14" TMX and 14" Stainless Steel Blades

BLADE OPERATION TIPS

- Be sure to mount the blade with the rotational arrow positioned the same direction as the tool rotates
- Follow circular saw manufacturer's warnings and instruction manual
- Check blade prior to use for any visible cracks, loose or missing teeth, etc. and change blade if found
- Use blade only on recommended material
- Mount blade between designated sides of blade washers matching arbor size and shape
- Always wear ANSI-approved eye protection and proper protective equipment
- Always wear gloves
- Adjust foot-plate of the saw to proper depth (check circular saw manual - 3 teeth exposed below material surface is a common rule of thumb)
- Always work in a clean and unobstructed work environment
- Never operate saw without working blade guard
- Do not use excessive pressure when cutting (this causes the blade to wear prematurely)
- Tighten blade bolt as instructed by saw manufacturer

Metal-Cutting Carbide Blades

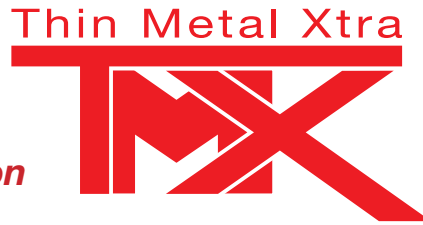

Cool cutting action
with long life



Fast, burr free cutting on:

- Angle Iron
- Rebar
- Steel Plate
- Channel Iron
- Pipe
- Threaded Rod
- C-Channel
- And other ferrous metals

Fast, burr free cutting on:

- Thin Metals
- Metal Studs
- Duct Work
- Sheet Metals
- Galvanized Roofing
- Thin Walled Pipe
- Conduit
- Strut Channel

METAL-CUTTING CARBIDE BLADES

CUTTING WHEELS

STEEL WORKER®	Diameter	Teeth	Grind	Arbor	RPM	Machine
77915	5-3/8 137mm	30	MTCG	20mm (10mm & 5/8" Bushing)	4,200	
77920	6-1/2 165mm	40	TCG	5/8 16mm	5,800	
77936	7 178mm	36	TCG	20mm	5,800	
77930	7-1/4 184mm	40	MTCG	5/8 16mm Diamond	5,800	
77940	8 203mm	42	MTCG	5/8 16mm Diamond	5,800	
77947	9 229mm	48	TCG	1 26mm	3,200	
77953	10 254mm	52	TCG	5/8 16mm	5,200	
77962	12 305mm	60	TCG	1 26mm	2,000	
77972	14 356mm	72	MTCG	1 26mm	1,800	

*Low RPM Metal Cutting Saw

TMX	Diameter	Teeth	Grind	Arbor	RPM	Machine
77921	6-1/2 165mm	48	ATB	5/8 16mm	5,800	
77931	7-1/4 184mm	68	ATB	5/8 16mm Diamond	5,800	
77965	12 305mm	80	MTCG	1 26mm	2,000	*
77975	14 356mm	90	MTCG	1 26mm	1,800	*

*Low RPM Metal Cutting Saw

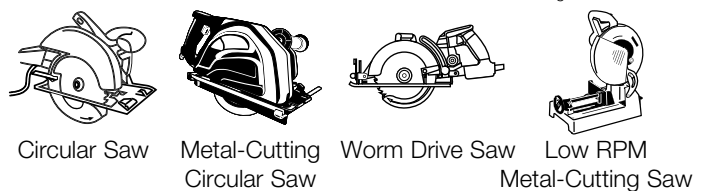

NOTE

- Blades must be run in the direction of the arrow as indicated on the blade.

TYPICAL END USERS/INDUSTRIES

- **STEEL WORKER®:** Steel Fabricators, Electricians, Welding, Weld Shops, Plumbers, Power Generation, Metal Contractors, Manufacturing/Fabrication, Maintenance/Repair
- **TMX - Thin Metal Extra:** General Contractors, Plumbers, Roofing Contractors, Maintenance/Repair, Electricians, Power Generation Contractors, Heating and Air Conditioning

Metal-Cutting Carbide Blades

STAINLESS

Cool cutting action with long life and minimal distortion



Fast, burr free cutting on:

- Tubing, bars, pipe, and stainless steel plate

STAINLESS	Diameter	Teeth	Grind	Arbor	RPM	Machine
77938	7 178mm	48	TCG	20mm	5,800	
77933	7-1/4 184mm	48	TCG	5/8 16mm Diamond	5,800	
77977	14 356mm	90	MTCG	1 26mm	1,800	*

*Low RPM Metal Cutting Saw

ALUMINUM

Cool cutting action with long life and minimal melting of aluminum



Fast, burr free cutting on:

- Aluminum, other non-ferrous metals and pipe

ALUMINUM	Diameter	Teeth	Grind	Arbor	RPM	Machine
77917	5-3/8 137mm	50	ATB	20mm (10mm & 5/8" Bushing)	4,200	
77922	6-1/2 165mm	60	ATB	5/8 16mm	5,800	
77937	7 178mm	54	ATB	20mm	5,800	
77932	7-1/4 184mm	60	ATB	5/8 16mm Diamond	5,800	
77942	8 203mm	60	TCG	5/8 16mm Diamond	5,800	
77955	10 254mm	80	TCG	5/8 16mm	5,200	*
77966	12 305mm	80	TCG	1 26mm	2,000	*
77976	14 356mm	80	ATB	1 26mm	1,800	*

*Low RPM Metal Cutting Saw

NOTE

- Blades must be run in the direction of the arrow as indicated on the blade.

TYPICAL END USERS/INDUSTRIES

- **Stainless:** Stainless Steel Contractors / Fabricators, Water Treatment Contractors, Kitchen Equipment Manufacturing, Power Generation Contractors
- **Aluminum:** Aluminum Contractors, Aluminum Foundries, Aluminum Grating and Fencing Contractors

CUTTING
WHEELS

METAL-CUTTING CARBIDE BLADES



Circular Saw Angle Grinder

DIAMOND

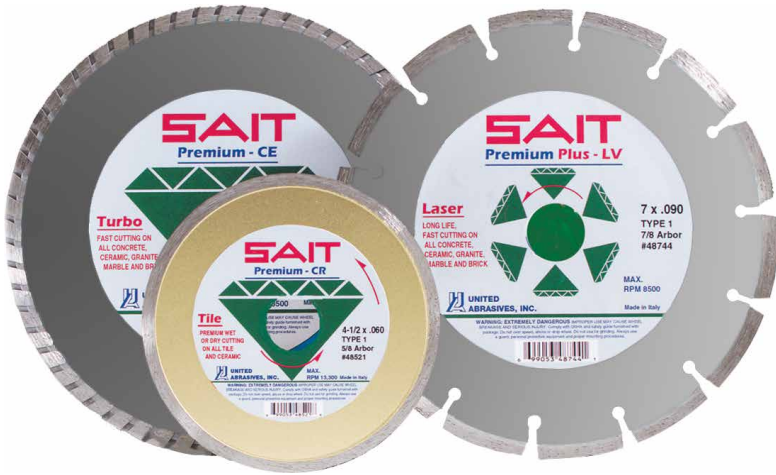

Available in a variety of sizes and styles for common cutting applications.



Continuous Rim (CR)

- Continuous uniform rim for smooth, dry and wet cutting of tiles and ceramic materials
- Longer lasting and faster cutting
- For use on small diameter electric saws

C Tile:

- Thin .060 for precise tile cutting

Tile & Ceramic

Size			Max RPM	Part No.	Qty Per Box	Qty Per Ctn	Lbs Per Box
A Dia.	B Width	C Bore		C Tile CR			
4-1/2	.060	7/8	13,300	48721	1	1	1
4-1/2	.060	5/8	13,300	48521	1	1	1



Serrated Rim (Turbo)

- Continuous rim with alternating serrations for fast, cool cutting
- Smooth cutting of almost any aggregate material
- For use on small diameter electric saws

CE/CC:

- CE is for general purpose cutting
- CC is a longer lasting and faster cutting premium wheel

CONCRETE Concrete, ceramic, granite, brick, blocks, marble

Size			Max RPM	Part Number		Qty Per Box	Qty Per Ctn	Lbs Per Box
A Dia.	B Width	C Bore		Turbo CE Prem	Turbo CC Prem +			
4-1/2	.090	7/8	13,300	48701	48711	1	1	1
4-1/2	.090	5/8	13,300	48501	48511	1	1	1
5	.090	7/8	12,200	48702	48712	1	1	1
5	.090	5/8	12,200	48502	48512	1	1	1
7	.090	7/8	8,500	48704	48714	1	1	1
7	.090	5/8	8,500	48504	48514	1	1	1



Circular Saw Angle Grinder



Segmented Rim (Laser)

- Segmented rim allows for a cool cutting
- Laser welded, segmented wheels

LU/LV:

- LU is for general purpose dry cutting
- LV is a longer lasting and faster dry cutting premium wheel
- **For use on small diameter electric saws**

CONCRETE Concrete, ceramic, granite, brick, blocks, marble

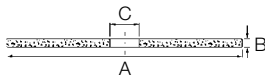

Size			Max RPM	Part Number		Qty Per Box	Qty Per Ctn	Lbs Per Box
A Dia.	B Width	C Bore		Laser LU Prem	Laser LV Prem +			
4-1/2	.090	7/8	13,300	48731	48741	1	1	1
4-1/2	.090	5/8	13,300	48531	48541	1	1	1
5	.090	7/8	12,200	48732	48742	1	1	1
5	.090	5/8	12,200	48532	48542	1	1	1
7	.090	7/8	8,500	48734	48744	1	1	1
7	.090	5/8	8,500	48534	48544	1	1	1



- Premium quality diamond for exceptional cutting and long life
- Laser welded bonding to the metal core on segmented wheels for cutting wet or dry
- Specifications available in general purpose wheels and premium wheels

COATED ABRASIVES

What is a Coated Abrasive?

A coated abrasive is a product that consists of a thin layer of abrasive grain attached to a substrate such as paper, cloth, etc. Coated abrasives come in a variety of forms such as sheets, discs, rolls, specialties, or belts.

Components of Coated Abrasives

Abrasive Grains

Coated abrasives are manufactured using abrasive grains; the most common are aluminum oxide, zirconium, ceramic, silicon carbide and garnet. The crude grains are crushed and separated into sizes, called grit sizes, using calibrated screens. Grits range from 12 (very coarse) to 1200 (very fine). Once the grains are separated into sizes, they are attached to a backing material using various bond techniques. Below are descriptions of the most common abrasive grains:

Ceramic:

A high performance, man-made abrasive material. Very uniform, high density grain structure is extremely durable and self sharpening for longer life and cooler cut. Excels on tough to grind materials.

Aluminum Oxide:

A tough, blocky shaped, man-made grain used for high speed grinding and finishing of metals, wood, and other high tensile strength materials without excessive fracturing or shedding. Wherever the ability to resist fracturing is the main consideration, aluminum oxide will outperform all other coated abrasive grains.

Zirconium:

A very fine, dense, man-made crystalline grain which can be used for aggressive stock removal. Zirconium is a very dense material with a unique self-sharpening characteristic which gives it long life on heavy stock removal operations.

Silicon Carbide:

A very hard, very sharp, man-made abrasive suited for non-ferrous materials and non-metallic materials such as concrete, marble and glass. A very friable grain, silicon carbide cuts faster under light pressure than any other grain used in coated abrasives.

Garnet:

Garnet is made of natural aluminum oxide which is a relatively sharp, but very weak bonding structure. Very inconsistent when compared to synthetics. It is used primarily in woodworking as garnet dulls too quickly to be used in metalworking.



Backing Materials (Substrates)

Below are the four major types of backing materials:

Paper

Specialized technical papers are used as substrates for coated abrasives. They are identified by letters representing weight and flexibility:

“A” and “B” weights are light weight and highly flexible. “C”, “D”, “E”, “F” weights are medium to heavy weight for more strength and less flexibility.

Cloth

Cloth backings are more durable than paper backings. There are several types of cloth backings: cotton (ie: Egyptian), polyester and polyester-cotton blends. Cloth backings are identified by weight and flexibility:

“F” weight (J-Flex) is light and highly flexible. This lighter weight is suitable for cleaning, finishing, and polishing.

“J” weight (Jeans) is highly flexible and suitable for cleaning, finishing, and polishing of contour surfaces.

“X” weight (Drills) is medium to heavy weight for more strength and durability. It has low flexibility suitable for grinding, deburring and finishing.

“H” (Heavy Duty) is a heavier weight than “X” weight. It has low flexibility and is suitable for heavy duty grinding and deburring applications. Excellent edge stability.

Fiber

Fiber backing is a tough vulcanized material made from rag stock. This backing is usually used for abrasive fiber discs.

Combination

Combination backing is laminated paper and cloth, and is very sturdy and shock resistant. Combination backings typically are used for a wide range of grits and mounting techniques.

Other Backing Materials

There are also a variety of other substrates such as nylon fiber or screens that can be coated for special applications. Non-woven nylon impregnated with abrasive grain is another substrate that can be used for cleaning, polishing, or blending.

Storage and Handling

Incorrect storage of coated abrasives will significantly affect performance. All types of backings are susceptible to variations in temperature and humidity during storage:

- Keep stockroom at constant levels of humidity (35-50%) and temperature (60-80° F)
- Keep cartons away from damp or cold walls and floors where they may absorb moisture
- Store coated abrasives away from any heat source
- Keep products in original packages for easy handling and stacking
- Flap wheels removed from the original packaging should be spread out on a clean shelf, always placed face down, never resting on edge
- Fiber discs removed from the original packaging should be stored in a suitable disc holder and kept under pressure
- Store bulk rolls flat on shelves or pallets, not on edge
- Belts removed from packing case should be rolled up and stood on edge on a clean shelf. They may be draped over a large cylinder but never hang a belt from a nail or peg (the backing will crease and the abrasive coat will crack)
- Precondition the coated abrasive products in a humidity and temperature controlled environment before use for maximum efficiency

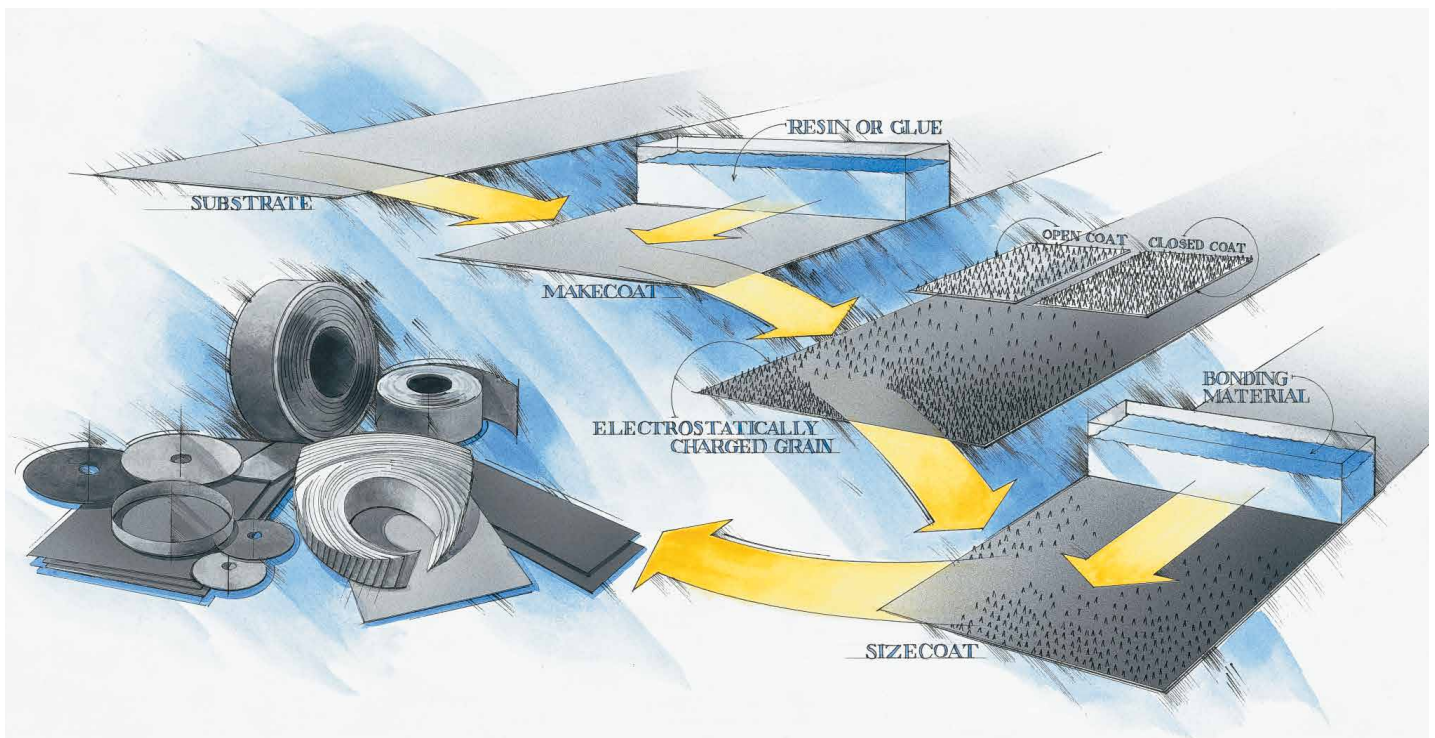

COATED
ABRASIVES



- We use only the **highest quality raw materials**, which are stored in an environmentally controlled area. These include grains, backings (such as paper, cotton, cotton-polyester and polyester materials) as well as resins and glues used in the process.
- One of the world's most modern, **highly automated, and state-of-the-art** coated abrasives production facilities.
- Our coated abrasives are cured in the latest, most updated, temperature controlled ovens to ensure that we produce a **consistent and quality finished product**, which is rigorously monitored every step of the way by our world renowned quality control department.
- SAIT Abrasives has been the world leader in producing the highest quality coated abrasives for over 50 years!

Coated Application Chart

Product	Structure	Adhesive	Backing/Weights	Form								
				Sheets	Rolls	SAIT-Saver	Quick Ship	Blue Line Belts	Custom Belt	Discs	Fiber Discs	Specialties
Cloth - Belts												
LA-X	Closed	Resin over Resin	X-Weight Cloth			•						
1A-X & 2A-X	Closed	Resin over Resin	X-Weight Cloth				•	•	•			
7A-S & 9A-S (contains grinding aid)	Closed	Resin over Resin	H-Weight Polyester						•			
3A-X	Closed	Resin over Resin	X-Weight Cloth					•				
AO-X	Open	Resin over Resin	X-Weight Cloth				•	•	•			
2A-H	Closed	Resin over Resin	H-Weight Polyester					•	•			
C-W	Closed	Resin over Resin	X-Weight Cloth				•	•	•			
Z-H	Closed	Resin over Resin	H-Weight Polyester				•	•	•			
3Z-H	Closed	Resin over Resin	H-Weight Polyester					•				
AZ-X	Closed	Resin over Resin	X Weight Poly/Cotton						•			
Cloth - Other												
Aluminum Oxide (AOX)	Open/Closed	Resin over Resin	J-Flex, J, X cloth	•	•	•	•				•	•
DA-F	Open	Resin over Resin	J-Flex Cloth		•							•
EA-F	Open	Resin over Resin	J-Flex Cloth	•	•							
TA-X	Closed	Resin over Resin	X Weight Cloth									•
2A-X	Closed	Resin over Resin	X Weight Cloth									•
3A-X	Closed	Resin over Resin	X Weight Cloth									•
Zirconium	Closed	Resin over Resin	X Cloth, H Polyester									•
3Z-H	Closed	Resin over Resin	H Polyester									•
AZ-X	Closed	Resin over Resin	X Weight Poly/Cotton				•					
Paper - Other												
Zirconium (Z-F)	Closed	Resin over Resin	F								•	
6S - Ceramic High Performance	Open	Resin over Resin	C	•							•	
Aluminum Oxide (AW-D/AW-C/A-E)	Open/Closed	Resin over Resin	C, D	•							•	
Stearate Aluminum Oxide (3S/6A)	Open	Resin over Resin	C	•							•	
Stearate Aluminum Oxide (4S/4V)	Open	Resin over Resin	C	•							•	
Silicon Carbide (CW-C)	Open/Closed	Resin over Resin	C	•							•	
Silicon Carbide (C-E/C-F)	Closed	Resin over Resin	E, F								•	
Garnet	Open	Glue over Glue		•								
Fiber												
7S & 7A-S (Ceramic Blended)	Closed	Resin over Resin										•
9S (Ceramic)	Closed w/ Coolants	Resin over Resin										•
AO (Aluminum Oxide)	Open	Resin over Resin										•
2A (Aluminum Oxide)	Closed	Resin over Resin										•
3A (Aluminum Oxide)	Closed w/ Coolants	Resin over Resin										•
AZ-X & Z (Zirconium)	Closed	Resin over Resin										•
3Z (Zirconium)	Closed w/ Coolants	Resin over Resin										•
C (Silicon Carbide)	Closed	Resin over Resin										•
Screens												
Silicon Carbide	N/A	Resin over Resin	Cloth screen impregnated with Silicon Carbide	•	•	•	•				•	
Non-Woven												
Aluminum Oxide/Silicon Carbide	N/A	N/A	Non woven nylon	•							•	
Silicate Compounds	N/A	N/A	Non woven nylon	•								
Buffing Discs	N/A	N/A	Buffing Cloth								•	
Flap Discs												
Flap Discs	Closed	Resin over Resin	Cloth								•	

COATED ABRASIVES

Coated Application Chart

Wet	Dry	Application
	•	General purpose, metalworking and woodworking
	•	Ordinary and alloyed steel, ferrous and non-ferrous metals, cast iron, wood
	•	High tensile steels, titanium, ferrous, non-ferrous metals
	•	Stainless steel and other heat sensitive materials, aluminum
	•	Ferrous, non-ferrous metals (steel, iron, aluminum, copper), wood, plastic, fiberglass
•	•	Ordinary and alloyed steel, ferrous and non-ferrous metals, cast iron
•	•	Hard cast iron, aluminum, glass, ceramics, marble and stone
•	•	Ordinary and alloyed steel, cast iron, aluminum, stainless steel
•	•	Stainless steel and other heat sensitive materials, aluminum
•	•	Ordinary and alloyed steel, cast iron, aluminum, stainless steel, wood
	•	Ferrous, non-ferrous metals (steel, iron, aluminum, copper), wood, plastic, fiberglass
	•	Ordinary and alloyed steel, ferrous and non-ferrous metals, cast iron, wood
	•	Ordinary and alloyed steel, ferrous and non-ferrous metals, cast iron, wood
	•	Ordinary and alloyed steel, ferrous and non-ferrous metals, cast iron, wood
	•	Ordinary and alloyed steel, ferrous and non-ferrous metals, cast iron, wood
	•	Stainless steel and other heat sensitive materials, aluminum
	•	Ordinary and alloyed steel, cast iron, aluminum, stainless steel
	•	Stainless steel and other heat sensitive materials, aluminum
	•	Wood floors
	•	Ferrous, non-ferrous metals, wood, plastic, fiberglass, sealers, fillers, paint, body filler
	•	Automotive-Sealers, body filler, paint, fiberglass, aluminum
•	•	Ferrous, non-ferrous metals, wood, plastic, fiberglass, sealers, fillers, paint
	•	Automotive-Sealers, body filler, paint, fiberglass, aluminum
	•	Automotive-Sealers, body filler, paint, fiberglass, aluminum
•	•	Body filler, paint, fiberglass, glass, wood, varnish, plastic, ceramics, marble, ferrous and non-ferrous metals
	•	Marble, granite, solid surface, ceramics, glass, fiberglass
	•	Soft woods
	•	High tensile steels, titanium, ferrous, non-ferrous metals
	•	Stainless steel, high tensile steels, titanium, aluminum, ferrous, non-ferrous metals
	•	Ferrous, non-ferrous metals, wood, fiberglass
	•	Ferrous, non-ferrous metals, wood, fiberglass
	•	Stainless steel, high tensile steels, titanium, aluminum, ferrous, non-ferrous metals
	•	Ferrous and non-ferrous metals, stainless steel, high tensile steels
	•	Stainless steel, high tensile steels, titanium, aluminum, ferrous, non-ferrous metals
	•	Glass, marble, ceramic, ferrous and non-ferrous metals
•	•	Fiberglass, body filler, paint, cement, ceramic, marble, wood, varnish, ferrous, non-ferrous metals
	•	Ferrous and non-ferrous metals, stainless steel, aluminum, wood, tile, rust and paint removal, cleaning welds
	•	Ferrous and non-ferrous metals, paint, varnish, ceramic, fiberglass, plastic, formica
	•	Buffing stainless steel, carbon steel, aluminum, non-ferrous metals
	•	Weld grinding, blending, and finishing



Description of Substrate

Backing	Flexibility
Cloth	
F	Lightest and most flexible
J	Very flexible
X	Medium to heavy weight Low flexibility
H	Heavier weight than "X" Low flexibility

COATED ABRASIVES

Paper

A	Lightest and most flexible
B	Heavier weight and less flexible than "A" weight
C	Medium weight and flexibility
D	Heavier weight and less flexible than "C" weight
E	Heavy Duty, low flexibility
F	Heavy Duty, extremely low flexibility

Fiber

Fiber backing is a tough vulcanized material used for fiber discs



FLAP DISCS

What is a Flap Disc?

- Flap discs are constructed by layering coated abrasive flaps so they wear away and expose new, sharp grain
- Flap discs increase productivity and reduce total grinding and finishing costs by grinding, blending & finishing in 1 step

BACKING SHAPE

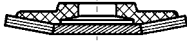
Conical shape features (type 29): 

- Built-in angle for increased contact area
- Best for use on contoured surfaces and edge work
- Minimizes workpiece gouging
- More aggressive stock removal due to higher angle
- 15°-25° working angle

Flat shape features (type 27): 

- Best for use on miter joints, corners and edges
- Best choice for finishing intricate and ornate surfaces
- Ideal for smooth finishing
- 0°-15° working angle

BACKING TYPE

Fiberglass backing features:

- Backing will wear uniformly with abrasive cloth
- Will not splinter or smear on the workpiece
- Lighter, quieter operation

Plastic backing features:

- Non-scratching, high strength backing
- Resistant to temperature extremes, common chemicals and solvents
- Some plastic backings are trimmable

DENSITIES

Regular Density

High Density

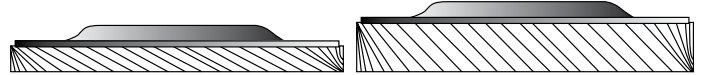

High density flap discs contain approximately 40% more material than regular density flap discs.

FLAP DISCS VS. GRINDING WHEELS

- Faster stock removal and smoother finish
- Quieter operation and reduced vibration minimizing operator fatigue
- Cooler cutting, reduced loading and glazing
- Easy to use – reduced gouging and rework

FLAP DISCS VS. FIBER DISCS

- Up to 20 times longer life than a fiber disc
- No backing pad needed
- Easier storage – no curling
- Flap discs should use one grit coarser than used in fiber discs (except 36 grit)
- More consistent finish

COATED
ABRASIVES



TWO TYPES OF PLASTIC BACKINGS

- **Soft ABS Plastic** designed to be trimmed to expose more abrasives material
- **Hard Plastic** designed for high strength and rigidity promoting ease of use and long-life

FIBERGLASS BACKING

- **Custom engineered fiberglass backing plates for strength and safety**
- More fiberglass than competitors – making our flap discs **among the safest on the market**

ADHESIVE SYSTEM

- **Specially formulated adhesive system**, designed to effectively secure the abrasive flaps to the backing, maximizes abrasive performance and safety

COATED MATERIAL

- **Our own coated material** has been specifically designed for flap discs
- Unique materials are used for each flap disc application

FLAP DESIGN

- We utilize **more and larger flaps** than our competitors to yield great performance and product life

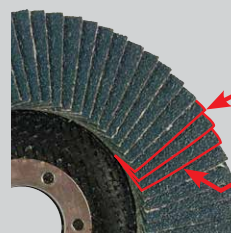

More flaps than competitive flap discs

Larger flaps than competitive flap discs

FLAP DISCS



FIBERGLASS BACKING

Regular Density



ENCORE p. 70

- General Purpose
- Premium Zirconium Grain
- Cotton Backing

ENCORE Ceramic p. 70

- High Performance Ceramic Grain
- Durable Polyester-Cotton Backing

High Density



OVATION® p. 72

- Heavy Duty
- Premium Zirconium Grain
- Full Tough Polyester Backing

OVATION® ATTACKER® p. 72

- Fast Cutting
- Premium Zirconium Grain
- Conformable Cotton Backing

OVATION® Ceramic p. 72

- High Performance Ceramic Grain
- Durable Polyester-Cotton Backing

PLASTIC BACKING

Regular Density



ENCORE Plus+ p. 71

- Ease of use & long life
- Premium Zirconium Grain
- Durable Polyester-Cotton Backing

ENCORE Ceramic Plus+ p. 71

- High Performance Ceramic Grain
- Ease of use & long life
- Durable Polyester-Cotton Backing

High Density



OVATION® Plus+ p. 73

- Heavy Duty
- Ease of use & long life
- Premium Zirconium Grain
- Full Tough Polyester Backing

OVATION® ATTACKER® Plus+ p. 73

- Ease of use & long life
- Premium Zirconium Grain
- Durable Polyester-Cotton Backing

OVATION® Ceramic Plus+ p. 73

- Ease of use & extra long life
- High Performance Ceramic Grain
- Durable Polyester-Cotton Backing

SPECIALTY

Encore Mini Flap Discs

p. 76



- 2" & 3" Diameters
- Zirconium Grain
- Long Life
- SAIT-LOK-R™ thread for easy changeover

SAIT GF Grind & Finish

p. 75



- Interleaf flap disc
- Combines coated & non-woven abrasives which allows you to "Grind & Finish" with one product reducing time & labor

4" Saitlam UK™

p. 76



- General Purpose
- Zirconium Grain

- Durable Polyester-Cotton Backing

Sand-Light™

p. 75



- Non-Woven Material
- Surface preparation & finishing

TRIMMABLE PLASTIC BACKING



TrimBack™ p. 74

- Trimmable
- Premium Zirconium Grain
- Durable Polyester-Cotton Backing

TrimBack™ Ceramic p. 74

- Trimmable
- High Performance Ceramic Grain
- Durable Polyester-Cotton Backing



COATED ABRASIVES

Regular Density

FLAP DISCS



ENCORE (Fiberglass Backing)



contaminant **cf** free

Fe+S+Cl FREE (<.1%)

APPLICATIONS:

- Weld grinding and blending
 - Deburring
- Finishing and blending
 - Contour finishing



LONG LIFE

SAIT ENCORE

- General Purpose Specification
- Premium zirconium grain on cotton backing which provides long life and high stock removal
- Resists loading on aluminum

METAL	Ferrous and/or non-ferrous metals
STAINLESS	Stainless steel, high tensile steel, titanium
ALUMINUM	Non-ferrous metals (aluminum, copper, brass, etc.)

SAIT

ENCORE Ceramic

- High performance
- Premium ceramic grain on a durable polyester-cotton backing provides high stock removal and **extra long life**

METAL	Ferrous and/or non-ferrous metals
STAINLESS	Stainless steel, high tensile steel, titanium

COATED ABRASIVES

FLAP DISCS



RPM's

4-1/2"	13,300
5"	12,200
6"	10,200
7"	8,500

Packaging
10/box
40/ctn

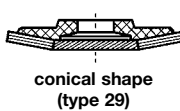
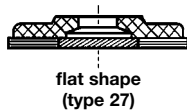

Size		Grit	Type 27	Type 29	Type 29
Dia.	Arbor		Part No. Encore	Part No. Encore	Part No. Encore Ceramic
4-1/2	7/8	36	71205	79105	72820
4-1/2	7/8	40	71206	79106	72821
4-1/2	7/8	60	71208	79108	72822
4-1/2	7/8	80	71209	79109	72823
4-1/2	7/8	120	71211	79111	-
4-1/2	5/8-11	36	71215	79115	72930
4-1/2	5/8-11	40	71216	79116	72931
4-1/2	5/8-11	60	71218	79118	72932
4-1/2	5/8-11	80	71219	79119	72933
4-1/2	5/8-11	120	71221	79211	-
5	7/8	36	71225	79125	72827
5	7/8	40	71226	79126	72828
5	7/8	60	71228	79128	72829
5	7/8	80	71229	79129	72830
5	7/8	120	71231	79131	-
5	5/8-11	36	71235	-	72937
5	5/8-11	40	71236	-	72938
5	5/8-11	60	71238	-	72939
5	5/8-11	80	71239	-	72940
5	5/8-11	120	71241	-	-
6	7/8	36	-	71245	-
6	7/8	40	-	71246	-
6	7/8	60	-	71248	-
6	7/8	80	-	71249	-
6	7/8	120	-	71251	-
6	5/8-11	36	-	71255	-
6	5/8-11	40	-	71256	-
6	5/8-11	60	-	71258	-
6	5/8-11	80	-	71259	-
6	5/8-11	120	-	71261	-
7	7/8	36	-	71265	-
7	7/8	40	-	71266	-
7	7/8	60	-	71268	-
7	7/8	80	-	71269	-
7	7/8	120	-	71271	-
7	5/8-11	36	-	71275	-
7	5/8-11	40	-	71276	-
7	5/8-11	60	-	71278	-
7	5/8-11	80	-	71279	-
7	5/8-11	120	-	71281	-

FLAP DISCS

ENCORE (Plastic Backing)

Regular Density



NEW!



contaminant **cf** free

Fe+S+Cl FREE (<.1%)

APPLICATIONS:

- Weld grinding and blending
- Deburring
- Finishing and blending
- Contour finishing

NEW!



Premium Performance!

SAIT ENCORE Plus+

- Long life
- Premium zirconium grain on a durable polyester-cotton backing provides fast cutting action and long life

METAL	Ferrous and/or non-ferrous metals
STAINLESS	Stainless steel, high tensile steel, titanium
ALUMINUM	Non-ferrous metals (aluminum, copper, brass, etc.)

SAIT ENCORE Ceramic Plus+

- High performance
- Premium ceramic grain on a durable polyester-cotton backing provides high stock removal and **extra long life**

METAL	Ferrous and/or non-ferrous metals
STAINLESS	Stainless steel, high tensile steel, titanium

LONG LIFE

COATED ABRASIVES



— Hard Plastic Backing —

- Ease of use reduces operator fatigue
- **Longer life** than fiberglass backing at the **same cost**



conical shape
(type 29)



RPM's	Packaging
4-1/2" 13,300	10/box
5" 12,200	40/ctn

Size		Grit	Part No. Encore Plus+	Part No. Encore Ceramic Plus+
Dia.	Arbor			
4-1/2	7/8	36	72238	72250
4-1/2	7/8	40	72239	72251
4-1/2	7/8	60	72240	72252
4-1/2	7/8	80	72241	72253
4-1/2	5/8-11	36	72338	72350
4-1/2	5/8-11	40	72339	72351
4-1/2	5/8-11	60	72340	72352
4-1/2	5/8-11	80	72341	72353
5	7/8	36	72244	72256
5	7/8	40	72245	72257
5	7/8	60	72246	72258
5	7/8	80	72247	72259
5	5/8-11	36	72344	72356
5	5/8-11	40	72345	72357
5	5/8-11	60	72346	72358
5	5/8-11	80	72347	72359

FLAP DISCS

High Density



FLAP DISCS



Angle Grinder

OVATION® (Fiberglass Backing)



PREMIUM

The Original
SAIT
OVATION®

- Excels on high pressure / heavy duty applications
- Premium zirconium grain on a tough, full polyester backing

METAL Ferrous and/or non-ferrous metals

STAINLESS Stainless steel, high tensile steel, titanium

OVATION®
ATTACKER®

- Excels on irregular surfaces in light pressure applications
- Premium zirconium grain on a cotton backing providing a softer-acting and faster cutting disc

STAINLESS Stainless steel, high tensile steel, titanium

METAL Ferrous metals

ALUMINUM Non-ferrous metals (aluminum, copper, brass, etc.)

SAIT
OVATION® Ceramic

- High performance product provides increased productivity
- Premium ceramic grain on a durable polyester-cotton backing provides high stock removal and extra long life

METAL Ferrous and/or non-ferrous metals

STAINLESS Stainless steel, high tensile steel, titanium

COATED ABRASIVES

FLAP DISCS



MORE GRINDING MATERIAL

contaminant **cf** free
Fe+S+Cl FREE (<.1%)

APPLICATIONS:

- Weld grinding and blending
- Deburring
- Finishing and blending
- Contour finishing

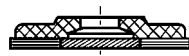

flat shape (type 27)



5/8-11 Hub



RPM's

4-1/2"	13,300
5"	12,200
6"	10,200
7"	8,500

Packaging
10/box
40/ctn

Size		Grit	Part No. Ovation®	Part No. Ovation® Attacker®	Part No. Ovation® Ceramic
Dia.	Arbor				
4-1/2	7/8	36	78005	-	78260
4-1/2	7/8	40	78006	76206	78261
4-1/2	7/8	60	78008	76208	78262
4-1/2	7/8	80	78009	76209	78263
4-1/2	7/8	120	78011	76211	-
4-1/2	5/8-11	36	78105	-	78320
4-1/2	5/8-11	40	78106	76316	78321
4-1/2	5/8-11	60	78108	76318	78322
4-1/2	5/8-11	80	78109	76319	78323
4-1/2	5/8-11	120	78111	76321	-
5	7/8	36	78025	-	78267
5	7/8	40	78026	76226	78268
5	7/8	60	78028	76228	78269
5	7/8	80	78029	76229	78270
5	7/8	120	78031	76231	-
5	5/8-11	36	78125	-	78327
5	5/8-11	40	78126	76336	78328
5	5/8-11	60	78128	76338	78329
5	5/8-11	80	78129	76339	78330
5	5/8-11	120	78131	76341	-
6	7/8	36	78035	-	-
6	7/8	40	78036	76236	-
6	7/8	60	78038	76238	-
6	7/8	80	78039	76239	-
6	7/8	120	78041	76241	-
6	5/8-11	36	78135	-	-
6	5/8-11	40	78136	76346	-
6	5/8-11	60	78138	76348	-
6	5/8-11	80	78139	76349	-
6	5/8-11	120	78141	76351	-
7	7/8	36	78045	-	-
7	7/8	40	78046	76246	-
7	7/8	60	78048	76248	-
7	7/8	80	78049	76249	-
7	7/8	120	78051	76251	-
7	5/8-11	36	78145	-	-
7	5/8-11	40	78146	76356	-
7	5/8-11	60	78148	76358	-
7	5/8-11	80	78149	76359	-
7	5/8-11	120	78151	76361	-

FLAP DISCS

OVATION® (Plastic Backing)

High Density



NEW!



NEW!



NEW!



SAIT Ovation® Plus+

- Excels on high pressure / heavy duty applications
- Premium zirconium grain on a tough, full polyester backing

- METAL** Ferrous and/or non-ferrous metals
- STAINLESS** Stainless steel, high tensile steel, titanium

OVATION® ATTACKER® Plus+

- Long life
- Premium zirconium grain on a durable polyester-cotton backing provides a fast cut and long life

- STAINLESS** Stainless steel, high tensile steel, titanium
- METAL** Ferrous metals
- ALUMINUM** Non-ferrous metals (aluminum, copper, brass, etc.)

SAIT Ovation® Ceramic Plus+

- High performance product provides increased productivity
- Premium ceramic grain on a durable polyester-cotton backing provides high stock removal and **extra long life**

- METAL** Ferrous and/or non-ferrous metals
- STAINLESS** Stainless steel, high tensile steel, titanium

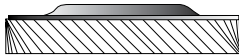

MORE GRINDING MATERIAL

contaminant **cf** free
Fe+S+Cl FREE (<.1%)

APPLICATIONS:

- Weld grinding and blending
- Deburring
- Finishing and blending
- Contour finishing

— Hard Plastic Backing —

- Ease of use reduces operator fatigue
- **Longer life** than fiberglass backing at the **same cost**



5/8-11 Super-Lock™ Hub

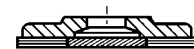

flat shape (type 27)



RPM's
4-1/2" 13,300
5" 12,200

Packaging
10/box
40/ctn

Size	Dia. Arbor		Grit	Ovation® Plus+	Ovation® Attacker® Plus+	Ovation® Ceramic Plus+
4-1/2	7/8	36	72200	72214	72226	
4-1/2	7/8	40	72201	72215	72227	
4-1/2	7/8	60	72202	72216	72228	
4-1/2	7/8	80	72203	72217	72229	
4-1/2	7/8	120	72204	-	-	
4-1/2	5/8-11	36	72300	72314	72326	
4-1/2	5/8-11	40	72301	72315	72327	
4-1/2	5/8-11	60	72302	72316	72328	
4-1/2	5/8-11	80	72303	72317	72329	
4-1/2	5/8-11	120	72304	-	-	
5	7/8	36	72207	72220	72232	
5	7/8	40	72208	72221	72233	
5	7/8	60	72209	72222	72234	
5	7/8	80	72210	72223	72235	
5	7/8	120	72211	-	-	
5	5/8-11	36	72307	72320	72332	
5	5/8-11	40	72308	72321	72333	
5	5/8-11	60	72309	72322	72334	
5	5/8-11	80	72310	72323	72335	
5	5/8-11	120	72311	-	-	

PREMIUM

COATED ABRASIVES

FLAP DISCS

Regular Density



Angle Grinder

FLAP DISCS

TrimBack (Trimmable Plastic)



Regular Density

- Specially designed trimmable ABS plastic – allows you to **easily trim away** the back of the disc to expose more abrasive material

APPLICATIONS:

- Weld grinding and blending
 - Deburring
- Finishing and blending
 - Contour finishing



TrimBack

- Long life
- Premium zirconium grain on a durable polyester-cotton backing provides fast cutting action and **long life**

METAL	Ferrous and/or non-ferrous metals
STAINLESS	Stainless steel, high tensile steel, titanium
ALUMINUM	Non-ferrous metals (aluminum, copper, brass, etc.)

TrimBack Ceramic

- High performance product provides increased productivity
- Premium ceramic grain on a durable polyester-cotton backing provides high stock removal and **extra long life**

METAL	Ferrous and/or non-ferrous metals
STAINLESS	Stainless steel, high tensile steel, titanium

PLASTIC BACKING

COATED ABRASIVES

FLAP DISCS



5/8-11 Super-Lock™ Hub

- **Unique 5/8-11 Hub Design** built for **Safety & Ease of Use:**
 - No machine flanges required
 - Heat & strip resistant metal threads

— TrimBack™ Do's and Don'ts —

DO

- Trim **ONLY** TrimBack™ flap discs to expose more abrasive overhang
- Mount the TrimBack™ on a properly guarded right angle grinder
- Apply the plastic backing to a secured metal workpiece while the grinder is running

DON'T

- Trim more than 1/4" of the plastic backing
- Trim beyond the maximum trim line or the ridged edge of the backing

RPM's	
4-1/2"	13,300
5"	12,200

Packaging	
10/box	
40/ctn	



Size			TrimBack Type 29 Part No.	TrimBack Type 27 Part No.	TrimBack Ceramic Part No.
Dia.	Arbor	Grit			
4-1/2	7/8	36	70800	70850	70821
4-1/2	7/8	40	70801	70851	70822
4-1/2	7/8	60	70802	70852	70823
4-1/2	7/8	80	70803	70853	70824
4-1/2	5/8-11	36	70910	70960	70921
4-1/2	5/8-11	40	70911	70961	70922
4-1/2	5/8-11	60	70912	70962	70923
4-1/2	5/8-11	80	70913	70963	70924
5	7/8	36	70807	70857	70827
5	7/8	40	70808	70858	70828
5	7/8	60	70809	70859	70829
5	7/8	80	70810	70860	70830
5	5/8-11	36	70917	70967	70927
5	5/8-11	40	70918	70968	70928
5	5/8-11	60	70919	70969	70929
5	5/8-11	80	70920	70970	70930

FLAP DISCS

NON-WOVEN & INTERLEAF

Specialty



Angle Grinder



SAIT GF
GRIND & FINISH



- Combines coated and non-woven abrasives which allows you to **"Grind & Finish" with one product** reducing time and labor
- Cushioned grinding effect allows for effortless blending and finishing of contoured work pieces
- Aluminum oxide specifications available in coarse, medium, and very fine
- Ceramic specification (High Performance) available in 40 grit and 60 grit - provides exceptionally long life

METAL Ferrous and/or non-ferrous metals

STAINLESS Stainless steel, high tensile steel, titanium

— Applications —

- Ideal for cleaning of weld spatter and light deburring operations
- Operate at lower speeds for optimum performance:
Optimal RPMs
4-1/2": 4,000 RPM | 5": 3,500 RPM

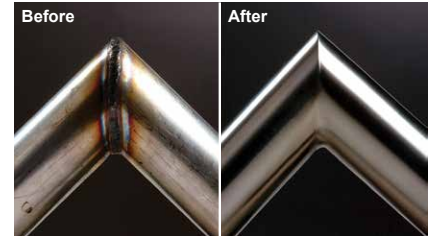

Allows you to grind down weld seams and provide a flawless finish in one single operation

State-of-the-art abrasive cloth for the quick, cool & controlled removal of material

Surface conditioning flaps ensure an even finish at low pressure

Size	Grade	Grit	Coated Abrasive Mat'l	Part No.	Qty Per Box
4-1/2" x 7/8"	Coarse	60	A/O	77720	10
	Medium	80	A/O	77721	10
	Very Fine	150	A/O	77723	10
5" x 7/8"	Coarse	40	Ceramic	77760	10
	Coarse	60	Ceramic	77761	10
	Coarse	60	A/O	77725	10
	Medium	80	A/O	77726	10
	Very Fine	150	A/O	77728	10
	Coarse	40	Ceramic	77766	10
	Coarse	60	Ceramic	77767	10

Max RPM's

4-1/2" 13,300
5" 12,200

Optimal RPM's

4-1/2" 4,000
5" 3,500



- 10pcs / canister (box)
- Product and features prominently displayed on canister



Sand-Light™ Flap Discs

- Non-woven material – layered flaps create a thick, cushioned design which provides a nice finish
- Designed for surface preparation, cleaning, and finishing applications

METAL Ferrous metals

STAINLESS Stainless steel, high tensile steel

ALUMINUM Non-ferrous metals

Size	Grade	Color	Part No.	Qty Per Box	RPM's
4-1/2" x 7/8"	Coarse	Brown	71980	5	13,300
	Medium	Maroon	71982	5	
	Very Fine	Blue	71984	5	
5" x 7/8"	Coarse	Brown	71990	5	12,200
	Medium	Maroon	71992	5	
	Very Fine	Blue	71994	5	

SPECIALTY

COATED ABRASIVES

FLAP DISCS

Specialty



Angle Grinder



Portable Grinder

FLAP DISCS SMALL DIAMETER



Saitlam U™ Winner Plus (Regular Density on Fiberglass Backing Plate)



Regular Density

APPLICATIONS:

Weld grinding and blending, deburring, finishing and blending, and contour finishing

- General purpose
- Zirconium grain on a durable polyester-cotton backing for

STAINLESS METAL ALUMINUM



Saitlam UK™ (conical shape - type 29)

- Conical shape ideal for working with large surfaces or complex shapes
- Working angle is "built-in"
- For general purpose stock removal and finishing

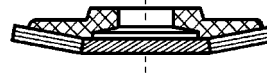

conical shape

Mat'l	Size		Grit	Part No. Saitlam UK™
	Dia.	Arbor		
Z Zirconium	4	5/8	40	73401
	4	5/8	60	73402
	4	5/8	80	73403
	4	5/8	120	73404

RPM's
4" 15,300

Packaging
10/box

SPECIALTY

COATED ABRASIVES

FLAP DISCS

SAIT ENCORE

Mini Flap Discs



- Long life performance of a flap disc for use in confined spaces
- More material, longer life than a single layer laminated disc
- SAIT-LOK-R™ thread allows easy changeover between sanding discs, surface conditioning discs and buffing discs

Size	Grit	SAIT-LOK-R™ Part No. Mini Encore
		40
2" Zirconium	60	74822
	80	74823
	120	74825
	40	74830
3" Zirconium	60	74832
	80	74833
	120	74835

See page 145 for SAIT-LOK-R™ backing pads

RPM's: Packaging
2" 30,000 10/box
3" 20,000

FIBER DISCS

INTRODUCTION

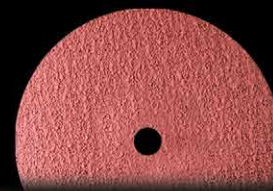

- Most comprehensive fiber discs product offering in the industry (10 types).
- Made with the highest quality materials using a premium resin over resin construction.
- Most renowned fiber discs in the world.

MATERIAL APPLICATION TECHNICAL INFORMATION

Aluminum Oxide Fiber Discs - Page 78



AO 16-120 Grit Range	<ul style="list-style-type: none"> • Economical choice for general grinding.
2A 16-120 Grit Range	<ul style="list-style-type: none"> • General purpose grinding and finishing. • Closed coat.
3A 36-120 Grit Range	<ul style="list-style-type: none"> • Best for grinding & finishing heat sensitive materials & non-ferrous metals. • Closed coat with grinding aids to reduce heat and loading.

Zirconium Fiber Discs - Page 79



AZX 24-80 Grit Range	<ul style="list-style-type: none"> • Economical zirconium fiber disc.
Z 24-80 Grit Range	<ul style="list-style-type: none"> • Closed coat for aggressive grinding and finishing.
3Z 24-80 Grit Range	<ul style="list-style-type: none"> • For aggressive grinding & finishing of heat sensitive materials & non-ferrous metals. • Closed coat with grinding aids to reduce heat and decrease loading.

Ceramic Fiber Discs - Page 80-81



7A-S 24-80 Grit Range	<ul style="list-style-type: none"> • Ceramic blended fiber disc - closed coat. • For use on carbon steel.
7S 24-80 Grit Range	<ul style="list-style-type: none"> • High performance ceramic grain, closed coat. • Excels on Carbon Steel - Very uniform, high density, grain structure is extremely durable and self-sharpening for long life and cooler cut.
9S 24-80 Grit Range	<ul style="list-style-type: none"> • High performance ceramic grain, closed coat with grinding aids for reduced heat and decreased loading. • Excels on Stainless Steel and tough to grind materials.

Silicon Carbide Fiber Discs - Page 82

C Silicon Carbide 16-400 Grit Range	<ul style="list-style-type: none"> • Closed coat for performance grinding and finishing of glass, marble, ceramic, hard cast iron and ferrous/non-ferrous materials.
--	---

Innovative Bulk Packaging (see picture on page 79)

Our unique bulk spindle packaging assures that each disc remains perfectly flat. The unique design offers the convenience of easy access and can be retightened to ensure that your discs are flat when you need them.

SAIT-LOK™ Quick Change 5/8-11 Hub

The SAIT-LOK™ hub recesses into the center cavity of the backing pad to provide a flat profile, thus increasing usable abrasive surface area up to 100% to get the job done faster and cooler.

- Eliminates the need for wrenches and spanner nuts.
- Threaded backing pad must be used with SAIT-LOK™ hub. Available in Blue Line™ packaging only.

Aluminum Oxide

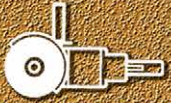

Angle Grinder

FIBER DISCS

GENERAL PURPOSE

COATED ABRASIVES

FIBER DISCS



AO



- Economical aluminum oxide grain for general grinding
- Open coat structure prevents loading
- **Fast material removal**

METAL Ferrous and/or non-ferrous metals (iron, steel, copper, aluminum, etc.)

WOOD Wood, fiberglass

2A

- Aluminum oxide grain
- **General purpose**
- Closed coat structure for more material removal and better finishing

METAL Ferrous and/or non-ferrous metals

WOOD Wood

3A

- Premium aluminum oxide grain with grinding aid
- **Special aluminum oxide grain to reduce heat build up and reduce loading**
- Closed coat structure for more material removal and better finishing

STAINLESS Stainless steel, high tensile steel, titanium

METAL Ferrous metals

ALUMINUM Non-ferrous metals (aluminum, copper, brass, etc.)

Size	Grit	Bulk (100 pcs.)			Blue Line™			SAIT-LOK™			
		Part No.			Part No.			Part No.			
		AO	2A	3A	AO	2A	3A	Pk Per Box	2A	3A	Pk Per Box
4 x 5/8	24	-	56024	-	-	50000	-	20	-	-	-
	36	-	56036	-	-	50001	-	20	-	-	-
	50	-	56050	-	-	50002	-	25	-	-	-
	60	-	56060	-	-	50003	-	25	-	-	-
	80	-	56080	-	-	50004	-	25	-	-	-
	100	-	56100	-	-	50005	-	25	-	-	-
120	-	56120	-	-	50006	-	25	-	-	-	
4-1/2 x 7/8	16	52416	51022	-	50090*	50008	-	20	-	-	15
	24	52424	51024	-	50091*	50010	-	20	50120	-	15
	36	52436	51036	52890	50092*	50011	50060	20	50121	50148	15
	50	52450	51050	52891	50093*	50012	50061	25	50122*	50149	15
	60	52460	51060	52892	50094*	50013	50062	25	50123	50150	15
	80	52480	51080	52893	50095*	50014	50063	25	50124	50151	15
100	52400	51100	52894	50096*	50015	50064	25	50125*	50152	15	
120	52420	51120	52895	50097*	50016	50065	25	50126*	50153	15	
5 x 7/8	16	52516	53016	-	50290*	50018	-	20	-	-	15
	24	52524	53024	-	50291*	50020	-	20	50127	-	15
	36	52536	53036	52810	50292*	50021	50040	20	50128	50154	15
	50	52550	53050	52811	50293*	50022	50041	25	50129*	50155*	15
	60	52560	53060	52812	50294*	50023	50042	25	50130	50156	15
	80	52580	53080	52813	50295*	50024	50043	25	50131	50157*	15
100	52500	53100	52814	50296*	50025	50044	25	50132*	50158*	15	
120	52520	53120	52815	50297*	50026	50045	25	50133*	50159	15	
7 x 7/8	16	52716	57016	-	50050	50030	-	20	-	-	15
	24	52724	57024	-	50051	50031	-	20	50134	-	15
	36	52736	57036	52836	50052	50032	50070	20	50135	50160	15
	50	52750	57050	52850	50383*	50033	50071	25	50136	50161*	15
	60	52760	57060	52860	50384*	50034	50072	25	50137*	50162*	15
	80	52780	57080	52880	50385*	50035	50073	25	50138	50163*	15
100	52700	57090	52100	50386*	50036	50074	25	50139*	50164*	15	
120	52720	57120	52125	50387*	50037	50075	25	50140	50165	15	
9-1/8 x 7/8	16	-	58016	-	-	50080	-	20	-	-	15
	24	-	58024	-	-	50081	-	20	50141*	-	15
	36	-	58036	-	-	50082	-	20	50142	-	15
	50	-	58050	-	-	50083	-	25	50143*	-	15
	60	-	58060	-	-	50084	-	25	50144	-	15
	80	-	58080	-	-	50085	-	25	50145	-	15
100	-	58090	-	-	50086	-	25	50146*	-	15	
120	-	58120	-	-	50087	-	25	50147*	-	15	

* Items are made to order (must order in multiples of 300 pcs)



- Resin over resin construction for a strong bond that is resistant to heat and moisture
- Vulcanized fiber backing for heavy duty sanding
- Available with SAIT-LOK™ quick change hub which extends disc life and requires fewer disc changes
- Available in bulk and Blue Line™ packaging

FIBER DISCS

Zirconium



Angle Grinder

AZX

- Economical zirconium fiber disc
- Fast grinding



STAINLESS Stainless steel, high tensile alloys

METAL Ferrous and/or non-ferrous metals (iron, steel, welds, etc.)

Z

- Zirconium grain
- Closed coat structure for aggressive stock removal and long life

STAINLESS Stainless steel, high tensile alloys

METAL Ferrous and/or non-ferrous metals (iron, steel, welds, etc.)

3Z

- Premium zirconium grain with grinding aid
- Special zirconium grain to reduce heat build up and reduce loading
- Closed coat structure for very aggressive material removal

STAINLESS Stainless steel, high tensile steel, titanium

METAL Ferrous metals

ALUMINUM Non-ferrous metals (aluminum, copper, brass, etc.)



Innovative Bulk Packaging
Fiber Spindle Keeps Discs Flat in Storage

- SAIT-LOK™ is available in Blue Line™ package only
See page 142 for SAIT-LOK™ backing pads
- Spiralcool™ backing pads and disc holder available for standard discs
See page 142 for Spiralcool™ backing pads

QT Quick Tip
Use the Zirconium fiber disc for aggressive stock removal on carbon steel.

Packaging

UPC bar coded Blue Line™ packaging or Industrial bulk pack of 100 pieces

Size	Grit	Bulk (100 pcs.)			Blue Line™			SAIT-LOK™			
		Part No.			Part No.			Part No.			
		AZX	Z	3Z	AZX	Z	3Z	Pk Per Box	Z	3Z	Pk Per Box
4-1/2 x 7/8	24	69224	59224	58224	60001*	59424	58424	20	50166	-	15
	36	69226	59236	58236	60002*	59436	58436	20	50167	50187	15
	50	69250	59250	58250	60003*	59450	58450	25	50168	50188*	15
	60	69260	59260	58260	60004*	59460	58460	25	50169	50189*	15
	80	69280	59280	58280	60005*	59480	58480	25	50170	50190	15
5 x 7/8	24	69324	59324	58324	60007*	59524	58524	20	50171	-	15
	36	69336	59336	58336	60008*	59536	58536	20	50172	50192*	15
	50	69350	59350	58350	60009*	59550	58550	25	50173	50193*	15
	60	69360	59360	58360	60010*	59560	58560	25	50174	50194*	15
	80	69380	59380	58380	60011*	59580	58580	25	50175	50195*	15
7 x 7/8	24	69624	59624	58624	60071*	59724	58724	20	50176	-	15
	36	69636	59636	58636	60072*	59736	58736	20	50177	50197	15
	50	69650	59650	58650	60073*	59750	58750	25	50178*	50198*	15
	60	69660	59660	58660	60074*	59760	58760	25	50179	50199	15
	80	69680	59680	58680	60075*	59780	58780	25	50180	50200*	15
9-1/8 x 7/8	24	-	59824	-	-	59924	-	20	50181*	-	15
	36	-	59836	-	-	59936	-	20	50182	-	15
	50	-	59850	-	-	59950	-	25	50183*	-	15
	60	-	59860	-	-	59960	-	25	50184*	-	15
	80	-	59880	-	-	59980	-	25	50185*	-	15

* Items are made to order (must order in multiples of 300 pcs)



- Resin over resin construction for a strong bond that is resistant to heat and moisture
- Vulcanized fiber backing for heavy duty sanding
- Available with SAIT-LOK™ quick change hub which extends disc life and requires fewer disc changes
- Available in bulk and Blue Line™ packaging

PREMIUM

COATED ABRASIVES

FIBER DISCS

7A-S/7S Ceramic

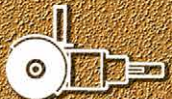

Angle Grinder

FIBER DISCS

HIGH PERFORMANCE

COATED ABRASIVES

FIBER DISCS



7A-S Ceramic

- Ceramic blended fiber disc, closed coat
- Fast aggressive stock removal
- **Economical ceramic fiber disc**



METAL Carbon steel, cast iron

Innovative Bulk Packaging
Fiber Spindle Keeps Discs Flat in Storage

7S Ceramic

- High performance, ceramic grain, closed coat
- **Excels on carbon steel, cast iron, and hard to grind alloys**
- Exceptional performance and value
- Available in bulk and Blue Line™
- **Very uniform, high density grain structure is extremely durable and self sharpening for long life and cooler cut**

METAL Carbon steel, cast iron



Note: Ceramic 7A-S & 7S SAIT-LOK™ & 7A-S Blue Line™ fiber discs are made to order (must order in multiples of 300 pcs)

Packaging

UPC bar coded Blue Line™ packaging or Industrial bulk pack of 100 pieces

See page 142 for backing pads

Size	Grit	Bulk (100 pcs.)		Blue Line™		Pk Per Box	SAIT-LOK™		Pk Per Box
		Part No.	Part No.	Part No.	Part No.		Part No.	Part No.	
		7A-S	7S	7A-S	7S		7A-S	7S	
4-1/2 x 7/8	24	59009	57424	50374	57224	20	55109	50999	15
	36	59010	57436	50375	57225	20	55110	51000	15
	50	59011	57450	50376	57226	25	55111	51001	15
	60	59012	57460	50377	57227	25	55112	51002	15
5 x 7/8	80	59013	57480	50378	57228	25	55113	51003	15
	24	59019	57524	50389	57234	20	55115	51007	15
	36	59020	57536	50390	57235	20	55116	51008	15
	50	59021	57550	50391	57236	25	55117	51009	15
7 x 7/8	60	59022	57560	50392	57237	25	55118	51010	15
	80	59023	57580	50393	57238	25	55119	51011	15
	24	59029	57724	50395	57244	20	55121	51015	15
	36	59030	57736	50396	57245	20	55122	51016	15
7 x 7/8	50	59031	57750	50397	57246	25	55123	51017	15
	60	59032	57760	50398	57247	25	55124	51018	15
	80	59033	57780	50399	57248	25	55125	51019	15



- Resin over resin construction for a strong bond that is resistant to heat and moisture
- Vulcanized fiber backing for heavy duty sanding
- Available with SAIT-LOK™ quick change hub which extends disc life and requires fewer disc changes
- Available in bulk spindle and Blue Line™ packaging

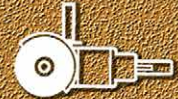

9S Ceramic (with grinding aid)

- High performance, ceramic grain, closed coat
- Grinding aids for reduced heat and decreased loading. Excels on heat sensitive materials (stainless steel, etc.) and non-ferrous metals (aluminum, etc.)
- Exceptional performance and value
- Excels on stainless steel and tough to grind materials

STAINLESS Stainless steel, high tensile steel, titanium

METAL Carbon steel, cast iron

ALUMINUM Non-ferrous metals (aluminum, copper, brass, etc.)



Grinds welds on stainless steel with no discoloration

Innovative Bulk Packaging
Fiber Spindle Keeps Discs Flat in Storage

Why use 9S?

- SAITECH™ 9S ceramic fiber discs are designed to keep the material that the disc is being used on very cool to prevent burning, discoloration and distortion.
- 9S is the ideal product for end users who frequently grind heat sensitive materials like stainless steel, high nickel, chrome alloys and titanium.
- 9S also works very well on aluminum and non-ferrous metals as the grinding aids act as a lubricant to prevent loading.



Size	Grit	Bulk (100 pcs.)		Blue Line™		SAIT-LOK™	
		Part No.	Part No.	Qty Per Box	Part No.	Qty Per Box	Part No.
4-1/2 x 7/8	24	51342	50510	20	50338	15	
	36	51343	50511	20	50339	15	
	50	51344	50512	25	50340	15	
	60	51345	50513	25	50341	15	
	80	59113	56313	25	50342	15	
5 x 7/8	24	51352	50520	20	50348	15	
	36	51353	50521	20	50349	15	
	50	51354	50522	25	50350	15	
	60	51355	50523	25	50351	15	
	80	59133	56333	25	50352	15	
7 x 7/8	24	51372	50530	20	50358	15	
	36	51373	50531	20	50359	15	
	50	51374	50532	25	50370	15	
	60	51375	50533	25	50371	15	
	80	59153	56353	25	50372	15	

Note: All SAIT-LOK™ Ceramic 9S fiber discs are made to order (must order in multiples of 300 pcs)

Packaging

UPC bar coded Blue Line™ packaging or Industrial bulk pack of 100 pieces

See page 142 for backing pads



- Resin over resin construction for a strong bond that is resistant to heat and moisture
- Vulcanized fiber backing for heavy duty sanding
- Available with SAIT-LOK™ quick change hub which extends disc life and requires fewer disc changes
- Available in bulk spindle and Blue Line™ packaging

HIGH PERFORMANCE

COATED ABRASIVES

FIBER DISCS

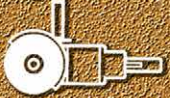

Recessed center hole to help avoid scratching of the surface.



Quick Tip

Use Spiralcool™ backing pads to extend disc life 30% to 50%.

C

- Silicon carbide grain
- Closed coat structure for more material removal

CONCRETE Glass, marble, ceramic, hard cast iron

METAL Ferrous and/or non-ferrous metals



Unique silicon carbide disc from extra coarse 16 grit to 400 grit.

Note: Fiber Discs must always be used with a backing pad.

Size	Grit	Bulk (100 pcs.) Part No.	Blue Line™	
			Part No.	Pk Per Box
7 x 7/8	16	54016	50100	20
	24	54024	50101	20
	36	54036	50102	20
	50	54050	50103	25
	60	54060	50104	25
	80	54080	50105	25
	100	54100	50106	25
	120	54120	50107	25
	150	54150	50108	25
	180	54180	50109	25
	220	54220	50110	25
	320	54320	50112	25
	400	54400	50113	25

Packaging

UPC bar coded Blue Line™ packaging or Industrial bulk pack of 100 pieces

See page 142 for backing pads



- Resin over resin construction for a strong bond that is resistant to heat and moisture
- Vulcanized fiber backing for heavy duty sanding
- Available in bulk and Blue Line™ packaging

STOCK & NON-STOCK BELTS

**NEW EXPANDED
OFFERING!**

***Over 3,000 Belt Items –
from file belts to wide belts
in paper, cotton, poly-cotton,
and polyester backings!***



www.UnitedAbrasives.com



STOCK BELTS

Stock Belts

- Most popular belt sizes available for immediate shipment.

Packaging

Quick Ship™ Belts

- Shrink-wrapped in quantities of 10.

SAIT-Saver™ Belts

- Economical choice - shrink-wrapped in quantities of 10.

Blue Line™ Belts

- Supplied in either 5 or 10 belts per box.
- Designed to be displayed on hooks or shelving.



Quick Ship™ & SAIT-Saver™ Belts



Blue Line™ Belts

Product Specifications

Aluminum Oxide Cloth - General Purpose

LA-X

- Semi-friable aluminum oxide grain on X-weight cotton backing.
- For low cost grinding and finishing of alloyed steels, ferrous and non-ferrous metals, cast iron and wood.
- 40-120 grit range / closed coat.

1A-X / 2A-X

- Semi-friable (1A-X)/heat-treated (2A-X) aluminum oxide grain on X-weight cotton backing.
- For general purpose grinding and finishing.
- For use on alloyed steels, ferrous and non-ferrous metals, cast iron and wood.
- 24-400 grit range / closed coat.

AO-X

- Semi-friable aluminum oxide grain on X-weight cotton backing.
- For general purpose, open coat grinding, polishing and finishing of materials that have the tendency to load.
- For use on non-ferrous metals, aluminum and wood.
- 24-180 grit range / open coat.

Zirconia Alumina Cloth - Premium

Z-H

- Zirconia alumina abrasive material on H-weight, waterproof polyester backing for heavy duty grinding and finishing.
- For use on ferrous and non-ferrous metals, cast iron, aluminum, and stainless steel.
- 24-80 grit range / closed coat.

COATED
ABRASIVES

BELTS

NON-STOCK BELTS



NEW EXPANDED OFFERING!

Non-Stock Belts

Call for Details

- Over **2,500 NEW ITEMS** available in portable belts, narrow belts, and wide belts.
- Lead-time of 7-10 business days (non-returnable).
- All non-stock belt quantities are subject to a manufacturing leeway of plus or minus 10%.

Non-Stock Belt Minimum Packaging and Sizes

- Portable File Belts - 50/box - 1/8" to 1" wide, 12" to 36" long
- Portable Belts - 10/box - 3" to 4" wide, 14" to 24" long
- Narrow Belts - 10/box - 1" to 20" wide, 12" to 300" long
- Wide Belts - 3/box 60 grit and coarser, 5/box 80 grit and finer - 25" to 54" wide, 48" to 128" long



Non-Stock Belt Specifications

Aluminum Oxide Cloth - General Purpose

1A-X / 2A-X - Semi-friable (1A-X)/heat-treated (2A-X) aluminum oxide grain on X-weight cotton backing. (page 84 full description)

AO-X - Semi-friable aluminum oxide grain on X-weight cotton backing. (page 84 full description)

2A-H

- Heat-treated, aluminum oxide grain on H-weight, waterproof polyester backing. 24-120 grit
- Excellent for heavy duty grinding and finishing ferrous and non-ferrous metals, cast iron, and aluminum. Excellent foundry belt material.

KA-F

- Semi-friable aluminum oxide grain on a very flexible cotton backing. 60-400 grit
- Flexible product for applications with medium to light pressure. Excels on curved and conformed surfaces.
- For use on ferrous and non-ferrous metals, wood, and leather.

AO-F (Paper)

- Semi-friable aluminum oxide grain on F-weight antistatic paper backing. 40-180 grit
- Extra open structure to reduce clogging on wood.

Silicon Carbide Cloth - Specialty

C-W

- Silicon carbide grain on waterproof X-weight cotton backing. 60-220 grit / closed coat.
- For grinding and finishing glass, hard cast iron, aluminum, ceramics, non-ferrous metals, plastics, rubber, marble and stone.

Zirconia Alumina Cloth - Premium

AZ-X

- Zirconia alumina abrasive material on X-weight, water-resistant polyester/cotton blended backing.
- For general purpose grinding and finishing on ferrous and non-ferrous metals, cast iron, aluminum, stainless steel and wood materials.
- 36-120 grit range / closed coat.

Z-H & 3Z-H (contains grinding aid for stainless steel) - Zirconia alumina abrasive material on H-weight, waterproof polyester backing for heavy duty grinding and finishing. (Description see page 84)

Ceramic Cloth - High Performance

7A-S & 9A-S (contains grinding aid for stainless steel).

- Ceramic abrasive material on H-weight, waterproof polyester backing. 36-80 grit / closed coat.
- For heavy duty grinding and finishing on metal, cast iron, and stainless steel.

COATED
ABRASIVES

BELTS



Portable Sander



File Sander



Backstand Sander



Benchstand Sander

BELTS

(Stock Belts)

Closed Coat
Aluminum
Oxide

Closed Coat
Zirconium

Closed Coat
Aluminum
Oxide

Closed Coat
Aluminum
Oxide

Closed Coat
Aluminum
Oxide

Open Coat
Aluminum
Oxide

Closed Coat
Zirconium

Size	Grit	1AX/2AX Quick Ship™ Part No.	Z-H Quick Ship™ Part No.	Size	Grit	1AX/2AX Blue Line™ Part No.	1AX/2AX Quick Ship™ Part No.	LA-X SAIT-Saver™ Part No.	AO-X Quick Ship™ Part No.	Z-H Quick Ship™ Part No.	
1/4 x 18	36	60016	64016	1 x 42	36		60310			58152	
	40	60017	64017		40		60311	60623		58153	
	50	60018	64018		50		60312	60624		58154	
	60	60019	64019		60		60313	60625		58155	
	80	60020	64020		80		60314	60626		58156	
	100	60021			100		60315	60627			
1/4 x 24	120	60022			120		60316	60628			
	36	60030	64030		150		60317				
	40	60031	64031		180		60318				
	50	60032	64032		220		60319				
	60	60033	64033		320		60322				
	80	60034	64034		1-1/2 x 60	36		61133			
100	60035		40				61134				
120	60036		60				61136				
3/8 x 13	36	61121				80		61137			
	40	61122		100			61138				
	50	61123		120			61139				
	60	61124		2 x 48		36		60506			
	80	61125				40		60507			
	100	61126				50		60508			
120	61127		60				60509				
1/2 x 12	36	60044				80		60510			
	40	60045				100		60511			
	50	60046		120			60512				
	60	60047		2 x 60		36		60520			
	80	60048				40		60521			
	100	60049			50		60522				
120	60050		60			60523					
1/2 x 18	36	60058	64058		80		60524				
	40	60059	64059		100		60525				
	50	60060	64060	120		60526					
	60	60061	64061	2 x 72	36		60534			64534	
	80	60062	64062		40		60535			64535	
	100	60063			50		60536			64536	
120	60064		60			60537			64537		
1/2 x 24	36	60086	64086		80		60538			64538	
	40	60087	64087		100		60539				
	50	60088	64088	120		60540					
	60	60089	64089	2 x 132	36		60576				
	80	60090	64090		40		60577				
	100	60091			50		60578				
120	60092		60			60579					
3/4 x 18	36	60114	64114		80		60580				
	40	60115	64115		100		60581				
	50	60116	64116	120		60582					
	60	60117	64117	2-1/2 x 14	40			63381			
	80	60118	64118		50			63382			
	100	60119			60			63383			
120	60120		80				63384				
3/4 x 20-1/2	36	60128	64128		100			63385			
	40	60129	64129		120			63386			
	50	60130	64130	2-1/2 x 60	36		61108			65108	
	60	60131	64131		40		61109			65109	
	80	60132	64132		50		61110			65110	
	100	60133			60		61111			65111	
120	60134		80			61112			65112		
1 x 21	36	60254			100		61113				
	40	60255		120		61114					
	50	60256		3 x 18	24	57100			63230		
	60	60257			36	57101			63231		
	80	60258			40	57102			63232		
	100	60259			50	57103			63233		
120	60260		60		57104			63234			
1 x 30	36	61094			80	57105			63235		
	40	61095			100	57106			63236		
	50	61096			120	57107			63237		
	60	61097			150	57108			63238		
	80	61098			180	57109					
	100	61099			220	57110					
120	61100		320		57113						

COATED
ABRASIVES

BELTS

BELTS

(Stock Belts)



Benchstand Sander Portable Sander

Size	Grit	Closed Coat Aluminum Oxide	Closed Coat Aluminum Oxide	Closed Coat Aluminum Oxide	Open Coat Aluminum Oxide	Open Coat Aluminum Oxide	Closed Coat Zirconium	Closed Coat Zirconium	
		1AX/2AX Blue Line™ Part No.	1AX/2AX Quick Ship™ Part No.	LA-X SAIT-Saver™ Part No.	AO-X Blue Line™ Part No.	AO-X Quick Ship™ Part No.	Z-H Blue Line™ Part No.	Z-H Quick Ship™ Part No.	
3 x 21	24	57200			58160				
	36	57201			58161				
	40	57202		55342	58162				
	50	57203		55343	58163				
	60	57204		55344	58164				
	80	57205		55345	58165				
	100	57206		55346	58166				
	120	57207		55347	58167				
	150	57208			58168				
	180	57209			58169				
	220	57210							
	320	57213							
3 x 24	24	57500			58170				
	36	57501			58171				
	40	57502		55352	58172				
	50	57503		55353	58173				
	60	57504		55354	58174				
	80	57505		55355	58175				
	100	57506		55356	58176				
	120	57507		55357	58177				
	150	57508			58178				
	180	57509			58179				
	220	57510							
	320	57513							
3 x 132	36		60772				64772		
	40		60773				64773		
	50		60774				64774		
	60		60775				64775		
	80		60776				64776		
	100		60777						
3-1/2 x 15-1/2	36		61145						
	40		61146						
	50		61147						
	60		61148						
	80		61149						
	100		61150						
4 x 21	24				58180				
	36				58181				
	40				58182				
	50				58183				
	60				58184				
	80				58185				
	100				58186				
	120				58187				
	150				58188				
	180				58189				
	4 x 24	24	57900			58190			
		36	57901			58191	58132		
40		57902		55362	58192	58133			
50		57903		55363	58193	58134			
60		57904		55364	58194	58135			
80		57905		55365	58195	58136			
100		57906		55366	58196				
120		57907		55367	58197				
150		57908			58198				
180		57909			58199				
220		57910							
320		57913							
4 x 36	24		60855						
	36		60856						
	40		60857	60663					
	50		60858	60664					
	60		60859	60665					
	80		60860	60666					
	100		60861	60667					
	120		60862	60668					
	150		60863						
	180		60864						
	220		60865						
	320		60868						
6 x 48	24		61023			63250			
	36		61024			63251	58142		
	40		61025	60683		63252	58143		
	50		61026	60684		63253	58144		
	60		61027	60685		63254	58145		
	80		61028	60686		63255	58146		
	100		61029	60687		63256			
	120		61030	60688		63257			
	150		61031			63258			
	180		61032			63259			
	220		61033						
	320		61036						

COATED ABRASIVES

BELTS

PAPER & CLOTH DISCS

Paper Discs

SPECIFICATION

MATERIAL & APPLICATION INFORMATION

Aluminum Oxide – Page 89 – 95

NEW!

6A Stearated Aluminum Oxide 80-400 Grit Range B-weight paper • Open Coat	<ul style="list-style-type: none"> • Economical choice • Stearate coating and open coat structure lubricates and prevents loading. • Available in PSA and hook and loop.
Gold Stearated Aluminum Oxide 80-400 Grit Range C and D weight paper • Semi Open Coat	<ul style="list-style-type: none"> • Stearate coating and semi open coat structure lubricates and prevents loading for fast cutting. • Available in PSA disc rolls.
3S Stearate Paper 80-600 Grit Range C-weight paper • Open Coat	<ul style="list-style-type: none"> • Stearate coating and open coat structure lubricates and prevents loading. • Available in PSA and hook and loop.
4S/4V Premium Stearate Paper 80-1500 Grit Range C-weight paper • Open Coat	<ul style="list-style-type: none"> • Premium stearate coating lubricates and prevents loading for long life and aggressive cutting. • Available in PSA and hook and loop.
A-E Heavy Duty Paper Discs 40-120 Grit Range E-weight paper • Open Coat	<ul style="list-style-type: none"> • Aggressive sanding, preparation, and stock removal as well as finishing with long life. • Heavier paper reduces torn edges, which produce deep, uneven random scratches. Available in PSA and hook and loop.

Zirconium – Page 95-96

Z-F Heavy Duty Paper Discs 40-120 Grit Range F-weight paper • Closed Coat	<ul style="list-style-type: none"> • Best choice for aggressive sanding, preparation, and stock removal. • Aggressive material removal and long life. • Heavy, F-weight paper. Available in PSA and hook and loop.
--	--

Ceramic – Page 90, 92, & 94

NEW!

6S Stearated Ceramic 80-400 Grit Range C-weight paper • Open Coat	<ul style="list-style-type: none"> • Best in class - premium ceramic paper. • Fast stock removal with exceptional long-life. • Stearate coating lubricates and prevents loading. • Available in PSA and hook and loop.
--	---

Silicon Carbide – Page 95

C-E and C-F Paper Discs 40-1200 Grit Range E and F weight paper • Closed Coat	<ul style="list-style-type: none"> • Premium Silicon Carbide paper for aggressive sanding and finishing. • For use on granite, marble, fiberglass, solid surface materials, ceramics, concrete, plastics and cast iron materials. • Heavy-duty paper. Available in hook and loop.
--	---

Cloth Discs

SPECIFICATION

MATERIAL & APPLICATION INFORMATION

Aluminum Oxide – Page 96 – 97

24-320 Grit Range X-weight cloth • Closed Coat	<ul style="list-style-type: none"> • X-weight cotton backing for grinding and finishing performance. • Hot melt adhesive provides excellent adhesion and easy removal.
---	--

Zirconium – Page 96 – 97

40-80 Grit Range X-weight cloth • Closed Coat	<ul style="list-style-type: none"> • X-weight cotton backing for superior grinding and finishing performance. • Hot melt adhesive provides excellent adhesion and easy removal.
--	---

COATED
ABRASIVES

PSA DISC ROLLS (PAPER) Stearated

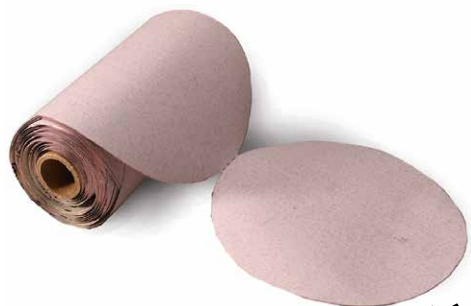

6A Stearated Aluminum Oxide

- OUR BEST ECONOMY DISC
- Aluminum oxide grain
- Stearate coating and open coat structure lubricates and prevents loading
- Available in weights: "B" light-weight, flexible

- PAINT** Body filler, paint, primers
- METAL** Ferrous metals
- ALUMINUM** Non-ferrous metals
- WOOD** Plastics, wood and fiberglass



3S Stearated Aluminum Oxide

- EXCELS ON WOOD AND BARE METAL SURFACES
- Aluminum oxide grain - For dry use only
- Stearate coating and open coat structure lubricates and prevents loading
- Available in weights: "C" medium-weight, average flexibility

- PAINT** Body filler, paint, primers
- METAL** Ferrous metals
- ALUMINUM** Non-ferrous metals
- WOOD** Plastics, wood and fiberglass



Gold Stearated Aluminum Oxide

- Aluminum oxide grain provides a fast cut with long life
- Stearate coating and semi open coat structure prevents loading - For dry use only
- For automotive body work, removing varnish from wood, sanding fiberglass, and for use on metal

- PAINT** Body filler, paint, primers
- METAL** Ferrous metals
- ALUMINUM** Non-ferrous metals
- WOOD** Plastics, wood and fiberglass

- For use on random orbital or low speed DA sanders
- Available weights: "C" - medium-weight, low flexibility
"D" - heavy-weight, low flexibility

Gold Disc Roll Packaging: 100 pieces/box/roll

Size	Grit	6A PSA Disc Rolls Part No	Gold PSA Disc Rolls Part No	3S PSA Disc Rolls Part No
5"	80	35410	36500	36800
	100	-	36501	36801
	120	35412	36502	36802
	150	35413	36503	36803
	180	35414	36504	36804
	220	35415	36505	36805
	240	-	36506	-
	320	35417	36508	36808
	400	-	36509	36809
	80	36410	36600	36900
6"	100	-	36601	36901
	120	36412	36602	36902
	150	36413	36603	36903
	180	36414	36604	36904
	220	36415	36605	36905
	240	-	36606	-
	320	36417	36608	36908
	400	-	36609	36909

Packaging
PSA Disc Rolls:
100 pcs/roll
4 rolls/box

See page 144 for backing pads



- Strong resin over resin bond construction is resistant to heat and moisture
- Special sharp and durable grain cuts fast and is long lasting
- PSA discs rolls are perforated for easy disc tear away from roll

COATED ABRASIVES

PAPER DISCS

Stearated PSA DISC ROLLS (PAPER)



Disc Sander



4S Premium Stearated Aluminum Oxide

- EXCELS ON PAINTED AND PRIMED SURFACES
- Fast removal rates for fine finishing of auto body, wood, metal, and marine applications
- Premium aluminum oxide grain
- Premium stearate coating and open coat structure lubricates and prevents loading - For dry use only
- Available in weights: "C" medium-weight, low flexibility

- PAINT** Body filler, paint, primers
- METAL** Ferrous metals
- ALUMINUM** Non-ferrous metals
- WOOD** Plastics, wood and fiberglass

6S Premium Stearated Ceramic

- BEST IN CLASS - PREMIUM CERAMIC GRAIN
- Premium stearated coating prevents loading
- Fast stock removal with exceptional long-life
- Available in weights: "C" medium-weight, low flexibility

- PAINT** Body filler, paint, primers
- METAL** Ferrous metals
- ALUMINUM** Non-ferrous metals
- WOOD** Plastics, wood and fiberglass

COATED ABRASIVES

PAPER DISCS

Size	Grit	4S PSA Disc Rolls Part No	6S PSA Disc Rolls Part No
5"	80	37800	35310
	100	37801	35311
	120	37802	35312
	150	37803	35313
	180	37804	35314
	220	37805	35315
	240	37806	-
	280	37807	-
	320	37808	35317
	6"	80	37900
100		37901	36311
120		37902	36312
150		37903	36313
180		37904	36314
220		37905	36315
240		37906	-
280		37907	-
320		37908	36317

Packaging
PSA Disc Rolls:
100 pcs/roll
4 rolls/box

See page 144 for backing pads

Tech
INFO

- Strong resin over resin bond construction is resistant to heat and moisture
- Special sharp and durable grain cuts fast and is long lasting
- PSA discs rolls are perforated for easy disc tear away from roll

INDIVIDUAL PSA (PAPER)

Stearated



6A Stearated Aluminum Oxide

- OUR BEST ECONOMY DISC
- Aluminum oxide grain
- Stearate coating and open coat structure lubricates and prevents loading
- Available in weights: "B" light-weight, flexible

- PAINT** Body filler, paint, primers
- METAL** Ferrous metals
- ALUMINUM** Non-ferrous metals
- WOOD** Plastics, wood and fiberglass

3S Stearated Aluminum Oxide

- EXCELS ON WOOD AND BARE METAL SURFACES
- Aluminum oxide grain - For dry use only
- Stearate coating and open coat structure lubricates and prevents loading
- Available in weights: "C" medium-weight, average flexibility

- PAINT** Body filler, paint, primers
- METAL** Ferrous metals
- ALUMINUM** Non-ferrous metals
- WOOD** Plastics, wood and fiberglass

Size	Grit	6A PSA Disc Part No	3S PSA Disc Part No
5"	80	35400	36520
	100	-	36521
	120	35402	36522
	150	35403	36523
	180	35404	36524
	220	35405	36525
	320	35407	36528
6"	400	35408	-
	80	36400	36620
	100	-	36621
	120	36402	36622
	150	36403	36623
	180	36404	36624
	220	36405	36625
	320	36407	36628



Quick Tip
Release paper keeps PSA discs clean in a dusty environment.



Packaging

PSA individual: 100/box
See page 144 for backing pads

Tech INFO

- Special sharp and durable grain cuts fast and is long lasting
- Pressure sensitive adhesive (PSA) backing allows for quick changes
- PSA discs are tabbed for easy removal of release paper

COATED ABRASIVES

PAPER DISCS

Stearated



Disc Sander

INDIVIDUAL PSA (PAPER)



4S Premium Stearated Aluminum Oxide

- EXCELS ON PAINTED AND PRIMED SURFACES
- Fast removal rates for fine finishing of auto body, wood, metal, and marine applications
- Premium aluminum oxide grain
- Premium stearate coating and open coat structure lubricates and prevents loading - For dry use only
- Available in weights: "C" medium-weight, low flexibility

- PAINT** Body filler, paint, primers
- METAL** Ferrous metals
- ALUMINUM** Non-ferrous metals
- WOOD** Plastics, wood and fiberglass

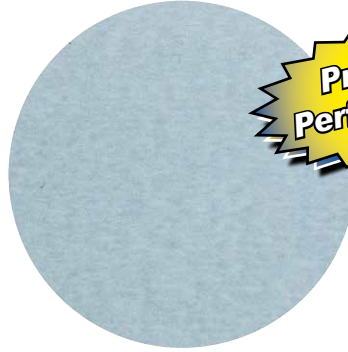

Premium Performance!

6S Premium Stearated Ceramic

NEW!

- BEST IN CLASS - PREMIUM CERAMIC GRAIN
- Premium steared coating prevents loading
- Fast stock removal with exceptional long-life
- Available in weights: "C" medium-weight, low flexibility

- PAINT** Body filler, paint, primers
- METAL** Ferrous metals
- ALUMINUM** Non-ferrous metals
- WOOD** Plastics, wood and fiberglass

COATED ABRASIVES

PAPER DISCS

Size	Grit	4S PSA Disc Part No	6S PSA Disc Part No
5"	80	37505	35300
	100	37506	35301
	120	37507	35302
	150	37508	35303
	180	37509	35304
	220	37510	35305
	320	37511	35307
6"	400	-	35308
	80	37605	36300
	100	37606	36301
	120	37607	36302
	150	37608	36303
	180	37609	36304
	220	37610	36305
320	37611	36307	
	400	-	36308



Quick Tip

Release paper keeps PSA discs clean in a dusty environment.



Packaging

PSA individual: 100/box
See page 144 for backing pads

Tech INFO

- Special sharp and durable grain cuts fast and is long lasting
- Pressure sensitive adhesive (PSA) backing allows for quick changes
- PSA discs are tabbed for easy removal of release paper

HOOK & LOOP (PAPER)

Stearated



Disc Sander

Premium Hook & Loop Fastening

- We only use premium high loft scrim which provides maximum gripping strength to the back up pad.
- Our high loft scrim helps to provide a better finish vs. other hook & loop attachments.

Easy Grit Identification

- We print the grit on the back of the disc to help ensure proper grit selection.

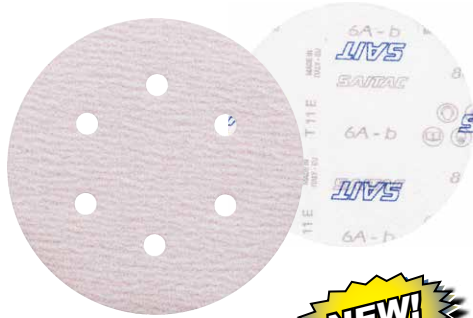
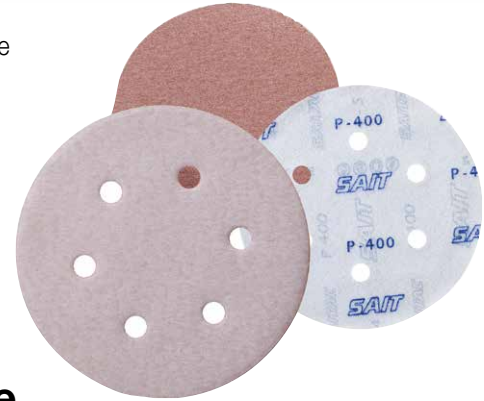

6A Stearated Aluminum Oxide

- OUR BEST ECONOMY DISC
- Aluminum oxide grain
- Stearate coating and open coat structure lubricates and prevents loading
- Available in weights: "B" light-weight, flexible

- PAINT** Body filler, paint, primers
- METAL** Ferrous metals
- ALUMINUM** Non-ferrous metals
- WOOD** Plastics, wood and fiberglass

3S Stearated Aluminum Oxide

- EXCELS ON WOOD AND BARE METAL SURFACES
- Aluminum oxide grain - For dry use only
- Stearate coating and open coat structure lubricates and prevents loading
- Available in weights: "C" medium-weight, average flexibility

- PAINT** Body filler, paint, primers
- METAL** Ferrous metals
- ALUMINUM** Non-ferrous metals
- WOOD** Plastics, wood and fiberglass



Packaging
50 pieces per box

See page 144 for backing pads now also available with vacuum holes

3S & 6A Hook & Loop Discs

Size	Grit	3S Hook & Loop Discs				6A Hook & Loop Discs			
		Part No. w/o vac. holes	Part No. w/ 5 vac. holes	Part No. w/ 6 vac. holes	Part No. w/ 8 vac. holes	Part No. w/o vac. holes	Part No. w/ 5 vac. holes	Part No. w/ 6 vac. holes	Part No. w/ 8 vac. holes
5"	80	36540	36550	-	36560	35420	35430	-	35440
	100	36541	36551	-	36561	-	-	-	-
	120	36542	36552	-	36562	35422	35432	-	35442
	150	36543	36553	-	36563	35423	35433	-	35443
	180	36544	36554	-	36564	35424	35434	-	35444
	220	36545	36555	-	36565	35425	35435	-	35445
	320	36548	36558	-	36568	35427	35437	-	35447
	400	-	-	-	-	35428	35438	-	35448
6"	80	36640	-	36650	-	36420	-	36430	-
	100	36641	-	36651	-	-	-	-	-
	120	36642	-	36652	-	36422	-	36432	-
	150	36643	-	36653	-	36423	-	36433	-
	180	36644	-	36654	-	36424	-	36434	-
	220	36645	-	36655	-	36425	-	36435	-
	320	36648	-	36658	-	36427	-	36437	-
	400	-	-	-	-	36428	-	36438	-



- Hook and loop fastening system allows for quick changes and less downtime
- Available with or without vacuum holes for use on random orbital or low speed DA sanders with capture systems
- Strong resin over resin bond construction is resistant to heat and moisture
- This special sharp and durable grain cuts fast and lasts long

COATED ABRASIVES

PAPER DISCS

Stearated



Disc Sander

HOOK & LOOP (PAPER)



Premium Hook & Loop Fastening

- We only use premium high loft scrim which provides maximum gripping strength to the back up pad.
- Our high loft scrim helps to provide a better finish vs. other hook & loop attachments.

Easy Grit Identification

- We print the grit on the back of the disc to help ensure proper grit selection.



4S/4V Premium Stearated Aluminum Oxide

- EXCELS ON PAINTED AND PRIMED SURFACES
- Fast removal rates for fine finishing of auto body, wood, metal, and marine applications
- Premium aluminum oxide grain - for dry use only
- Premium stearate coating and open coat structure lubricates and prevents loading

- PAINT** Body filler, paint, primers
- METAL** Ferrous metals
- ALUMINUM** Non-ferrous metals
- WOOD** Plastics, wood and fiberglass



6S Premium Stearated Ceramic

- **BEST IN CLASS - PREMIUM CERAMIC PAPER**
- Premium steared coating prevents loading
- **Fast stock removal with exceptional long-life**
- Available in weights: "C" medium-weight, low flexibility

- PAINT** Body filler, paint, primers
- METAL** Ferrous metals
- ALUMINUM** Non-ferrous metals
- WOOD** Plastics, wood and fiberglass



4S/4V & 6S Hook & Loop Discs

Size	Grit	4S/4V Hook & Loop Discs				6S Hook & Loop Discs			
		Part No. w/o vac. holes	Part No. w/ 5 vac. holes	Part No. w/ 6 vac. holes	Part No. w/ 8 vac. holes	Part No. w/o vac. holes	Part No. w/ 5 vac. holes	Part No. w/ 6 vac. holes	Part No. w/ 8 vac. holes
5"	60C	37501	37533	-	37534	35319	35329	-	35339
	80C	37515	37525	-	37535	35320	35330	-	35340
	100C	37516	37526	-	37536	35321	35331	-	35341
	120C	37517	37527	-	37537	35322	35332	-	35342
	150C	37518	37528	-	37538	35323	35333	-	35343
	180C	37519	37529	-	37539	35324	35334	-	35344
	220C	37520	37530	-	37540	35325	35335	-	35345
	240C	37562	-	-	-	-	-	-	-
	280C	37563	-	-	-	-	-	-	-
	320C	37521	37531	-	37541	35327	35337	-	35347
	400C	37522	37532	-	37542	35328	35338	-	35348
	500C	37523	-	-	-	-	-	-	-
	600C	37524	-	-	-	-	-	-	-
	800C	37550	37554	-	37543	-	-	-	-
	1000C	37551	37555	-	37544	-	-	-	-
1200C	37552	37556	-	37545	-	-	-	-	
1500C	37553	37557	-	37546	-	-	-	-	
6"	60C	37601	-	37634	-	36319	-	36329	-
	80C	37615	-	37635	-	36320	-	36330	-
	100C	37616	-	37636	-	36321	-	36331	-
	120C	37617	-	37637	-	36322	-	36332	-
	150C	37618	-	37638	-	36323	-	36333	-
	180C	37619	-	37639	-	36324	-	36334	-
	220C	37620	-	37640	-	36325	-	36335	-
	240C	37650	-	-	-	-	-	-	-
	280C	37651	-	-	-	-	-	-	-
	320C	37621	-	37641	-	36327	-	36337	-
	400C	37622	-	37642	-	36328	-	36338	-
	500C	37623	-	-	-	-	-	-	-
	600C	37624	-	-	-	-	-	-	-
	800C	37625	-	37643	-	-	-	-	-
	1000C	37626	-	37644	-	-	-	-	-
1200C	37627	-	37645	-	-	-	-	-	
1500C	37628	-	37646	-	-	-	-	-	



- Hook and loop fastening system allows for quick changes and less downtime
- Available with or without vacuum holes for use on random orbital or low speed DA sanders with capture systems
- Strong resin over resin bond construction is resistant to heat and moisture
- This special sharp and durable grain cuts fast and lasts long

COATED ABRASIVES

PAPER DISCS

HOOK & LOOP & PSA (PAPER)

Heavy Duty



Disc Sander



Zirconium Paper Discs - Z-F (Premium)

- Best choice for aggressive sanding, preparation, and stock removal
- Zirconium grain for aggressive material removal and long life
- Heavy, F-weight paper prevents torn edges which produce deep, uneven random scratches

METAL Ferrous and non-ferrous metals

WOOD Wood



Quick Tip

Release paper keeps PSA discs clean in a dusty environment.



Aluminum Oxide Paper Discs - A-E

- For aggressive sanding, preparation, and stock removal
- Aluminum oxide grain for material removal, long life and finishing
- E-weight paper reduces torn edges which produce deep, uneven random scratches

WOOD Wood, auto body applications, and fiberglass

METAL Ferrous and non-ferrous metals



Size	Grit	AE - Aluminum Oxide				Z-F Zirconium		
		H&L Part No. w/o vac. holes	H&L Part No. w/ 5 vac. holes	H&L Part No. w/ 6 vac. holes	H&L Part No. w/ 8 vac. holes	PSA Part No.	Hook & Loop Part No.	PSA Part No.
5"	40	34250	34280	-	34290	34150	34210	34110
	60	34252	34282	-	34292	34152	34212	34112
	80	34253	34283	-	34293	34153	34213	34113
	120	34255	34285	-	34295	34155	34215	34115
6"	40	34270	-	34310	-	34170	34230	34130
	60	34272	-	34312	-	34172	34232	34132
	80	34273	-	34313	-	34173	34233	34133
	120	34275	-	34315	-	34175	34235	34135
8"	40	-	-	-	-	-	34240	34140
	80	-	-	-	-	-	34243	34143



Packaging

5" and 6": 50/box
8": 25/box

See page 144 for backing pads now also available with vacuum holes

Silicon Carbide Paper Discs

Size	Grit	Hook & Loop Part No.
5"	40	34510
	60	34512
	80	34513
	100	34514
	120	34515
	150	34516
	180	34517
	220	34518
	320	34521
	400	34522
	500	34523
	600	34524
6"	800	34525
	1200	34527
	40	34610
	60	34612
	80	34613
	100	34614
	120	34615
	150	34616
	180	34617
	220	34618
	320	34621
	400	34622
500	34623	
600	34624	
800	34625	
1200	34627	

Silicon Carbide Heavy Duty Paper Discs

C-E/C-F Discs

- Premium silicon carbide grain on a tough paper backing
- Designed for fine finishing and long life
- Available with hook and loop backing

CONCRETE Marble, granite, solid surface, ceramics, concrete, plastic

METAL Ferrous and non-ferrous metals



Contour Hand Pads on page 144



- PSA and Hook and loop fastening systems allow for quick changes and less downtime
- Hook and loop available with or without vacuum holes for use on random orbital or low speed DA sanders with capture systems
- PSA discs are tabbed for easy removal of release paper
- Strong resin over resin bond construction is resistant to heat and moisture
- This special sharp and durable grain cuts fast and lasts long

COATED ABRASIVES

PAPER DISCS



Zirconium (Premium)

Premium Zirconium Grain

- Specially formulated X-weight Egyptian cotton cloth backing
- Closed coat structure

METAL Ferrous and/or non-ferrous metals (iron, steel, aluminum, copper, etc.)

STAINLESS Stainless steel, high tensile steel

Packaging

1" - 6"	50/pkg
7" - 12"	25/pkg
14" - 16", 18", 20"	10/pkg

See page 144 for backing pads

* 220 grit not available

** 280 grit not available

COATED
ABRASIVES

CLOTH DISCS

Size	Part No. TA-X	Grit Available
1"	34990	50
	34991	60
	34992	80
	34993	100-120-150- thru 180-220-
	34999	240-320
1-1/2"	35003	50
	35004	60
	35005	80
	35007	120
2"	35020	24
	35021	36
	35022	40
	35023	50
	35024	60
	35025	80
	35026	100-120-150- thru 180-**-
35033	240-**-320	
3"	35040	24
	35041	36
	35042	40
	35043	50
	35044	60
	35045	80
	35046	100-120-150- thru 180-220- 240-**-320
4"	35060	24
	35061	36
	35062	40
	35063	50
	35064	60
	35065	80
	35066	100-120-150- thru 180-220- 240-**-320
	35073	240-**-320

Size	Part No.		Grit Available
	TA-X	Z-X	
5"	35080	-	24
	35081	-	36
	35082	37082	40
	35083	37083	50
	35084	37084	60
	35085	37085	80
	35086	-	100-120-150- thru 180-220- 240-**-320
6"	35094	-	24
	35095	-	36
	35096	37096	40
	35097	37097	50
	35098	37098	60
	35099	37099	80
	35100	-	100-120-150- thru 180-220- 240-**-320
7"	35107	-	24
	35108	-	36
	35109	-	40
	35110	-	50
	35111	-	60
	35112	-	80
	35113	-	100-120-150- thru 180-220- 240-**-320
8"	35114	-	24
	35122	-	36
	35123	-	40
	35124	37124	50
	35125	37125	60
	35126	37126	80
	35127	37127	100-120-150- thru 180-220- 240-**-320
	35128	-	24
35135	-	36	

Tech INFO

- Strong resin over resin bond construction is resistant to heat and moisture
- Hot melt adhesive back allows for quick change and less downtime
- Label UPC bar coded for easy identification and inventory maintenance

CLOTH DISCS

PSA Discs



Aluminum Oxide

Aluminum Oxide Grain

- Strong X-weight Egyptian cotton cloth backing
- Closed coat structure

METAL Ferrous and/or non-ferrous metals (iron, steel, aluminum, copper, etc.)

WOOD Wood, plastic, fiberglass



See page 96 for packaging

Size	Part No.		Grit Available
	TA-X	Z-X	
9"	35136	-	24
	35137	-	36
	35138	37138	40
	35139	37139	50
	35140	37140	60
	35141	37141	80
	35142	-	100-120-150-thru
10"	35149	-	180-220-240-**-320
	35150	-	24
	35151	-	36
	35152	-	40
	35153	-	50
	35154	37154	60
	35155	37155	80
	35156	-	100
	35157	-	120
	35158	-	150
12"	35164	-	24
	35165	-	36
	35166	37166	40
	35167	37167	50
	35168	37168	60
	35169	37169	80
	35170	-	100-120-150-thru
14"	35177	-	180-220-240-**-320
	35179	-	36
	35180	-	40
	35181	-	50
	35182	-	60
	35183	-	80

Size	Part No.		Grit Available
	TA-X	Z-X	
15"	35193	-	36
	35194	-	40
	35195	-	50
	35196	-	60
	35197	-	80
16"	35207	-	36
	35208	-	40
	35209	-	50
	35210	-	60
	35211	-	80
18"	35212	-	100
	35213	-	120
	35221	-	36
	35222	-	40
	35223	-	50
	35224	-	60
	35225	-	80
20"	35235	-	36
	35236	37236	40
	35237	37237	50
	35238	37238	60
	35239	37239	80
	35240	-	100
	35241	-	120



- Strong resin over resin bond construction is resistant to heat and moisture
- Hot melt adhesive back allows for quick change and less downtime
- Label UPC bar coded for easy identification and inventory maintenance

COATED ABRASIVES

CLOTH DISCS

Heavy Duty



Portable Grinder

LAMINATED AND MINI FLAP DISCS

Triple laminated construction for severe pressure applications where conventional laminated discs have too much flex. Excellent for edge grinding, deburring, and weld preparation and removal.

2A-H

- Aluminum oxide grain
- **Fast stock removal**
- Excellent edge grain retention

METAL Ferrous and/or non-ferrous metals

WOOD Wood, plastic, fiberglass, etc.

Z-H

- High performance zirconium grain
- **Extremely fast stock removal and long life**

METAL Ferrous and/or non-ferrous metals

STAINLESS Stainless steel, high tensile alloys



SAIT-LOK™

Improved nylon composite won't bend or break during aggressive applications. Uses the same backing pad as conventional laminated discs.

SAIT-LOK-R™



Nylon screw threaded hub for easy mounting to the backing pad

Size	Grit	SAIT-LOK™ Part No.		SAIT-LOK-R™ Part No.		Qty Per Box
		2A-H	Z-H	2A-H	Z-H	
2"	24	52320	55420	50320	55450	100
	36	52321	55421	50321	55451	100
	50	52322	55422	50322	55452	100
	60	52323	55423	50323	55453	100
	80	52324	55424	50324	55454	100
3"	24	52330	55430	50330	55460	50
	36	52331	55431	50331	55461	50
	50	52332	55432	50332	55462	50
	60	52333	55433	50333	55463	50
	80	52334	55434	50334	55464	50

HEAVY DUTY

COATED ABRASIVES

LAMINATED DISCS



SAIT ENCORE

Mini Flap Discs

- Long life performance of a flap disc for use in confined spaces
- More material, longer life than a single layer laminated disc
- SAIT-LOK-R™ thread allows easy changeover between sanding discs, surface conditioning discs and buffing discs

Packaging 10/box

Size	Grit	SAIT-LOK-R™ Part No. Mini Encore
2"	40	74820
	60	74822
	80	74823
	120	74825
3"	40	74830
	60	74832
	80	74833
	120	74835

See page 145 for SAIT-LOK-R™ backing pads



Heavy Duty Discs

Stiffer construction assures fast grinding performance
Very durable edge performance & long life



Conventional Discs

See page 145 for backing pads

Tech INFO

- Triple lamination construction for severe duty applications where traditional discs fray
- Quick change backings make for fast, easy disc changes and less downtime
- Universal style backings fit most major backing pad brands on the market

LAMINATED DISCS

Aluminum Oxide



Portable Grinder



SAIT-LOK™

All-metal attachment on disc ensures a secure fit to the backing pad (see page 100 for photo)

SAIT-LOK-R™

Nylon screw threaded hub for easy mounting to the backing pad (see page 100 for photo)

See page 145 for backing pads

2A

- Aluminum oxide grain
- **General purpose, long life**
- Easy disc changes by twisting to unlock backing pad

METAL Ferrous and/or non-ferrous metals

WOOD Wood, plastic, fiberglass, etc.

3A

- Premium aluminum oxide grain with grinding aid
- Cooling agents for cool cutting and long life
- **Fast stock removal**
- Easy disc changes by twisting to unlock backing pad

STAINLESS Stainless steel, high tensile steel, titanium

METAL Ferrous and/or non-ferrous metals



Quick Tip

Use 3A or 3Z for top performance on stainless steel and aluminum.

Size	Grit	SAIT-LOK™ Part No.		SAIT-LOK-R™ Part No.		Qty Per Box
		2A	3A	2A	3A	
1"	36	52208	50208	-	-	100
	40	52209	50209	-	-	100
	50	52210	50210	-	-	100
	60	52211	50211	-	-	100
	80	52212	50212	-	-	100
	100	52213	50213	-	-	100
	120	52214	50214	-	-	100
1-1/2"	36	52215	50215	52264	50264	100
	40	52216	50216	52265	50265	100
	50	52217	50217	52266	50266	100
	60	52218	50218	52267	50267	100
	80	52219	50219	52268	50268	100
	100	52220	50220	52269	50269	100
	120	52221	50221	52270	50270	100
2"	36	52222	50222	52271	50271	100
	40	52223	50223	52272	50272	100
	50	52224	50224	52273	50273	100
	60	52225	50225	52274	50274	100
	80	52226	50226	52275	50275	100
	100	52227	50227	52276	50276	100
	120	52228	50228	52277	50277	100
3"	36	52229	50229	52278	50278	50
	40	52230	50230	52279	50279	50
	50	52231	50231	52280	50280	50
	60	52232	50232	52281	50281	50
	80	52233	50233	52282	50282	50
	100	52234	50234	52283	50283	50
	120	52235	50235	52284	50284	50

Tech INFO

- 2-ply construction is rugged enough for contoured surfaces or flat surfaces
- Quick-change backings make for fast, easy disc changes and less downtime
- Universal backings fit most major backing pad brands on the market

GENERAL PURPOSE

COATED ABRASIVES

LAMINATED DISCS

Zirconium



Portable Grinder

LAMINATED DISCS

SAIT-LOK™



All-metal attachment on disc ensures a secure fit to the backing pad

SAIT-LOK-R™



Nylon screw threaded hub for easy mounting to the backing pad

See page 145 for backing pads



PREMIUM

COATED ABRASIVES

LAMINATED DISCS

Z

- Premium zirconium grain
- **Very fast stock removal, long life**
- Easy disc changes by twisting to unlock backing pad

STAINLESS Stainless steel, high tensile alloys

METAL Ferrous and/or non-ferrous metals (iron, steel, welds, etc.)

3Z

- Premium zirconium grain with grinding aid
- Cooling agents for cool cutting and long life
- **Very fast stock removal, no discoloration**
- Easy disc changes by twisting to unlock backing pad

STAINLESS Stainless steel, high tensile steel, titanium

METAL Ferrous and/or non-ferrous metals

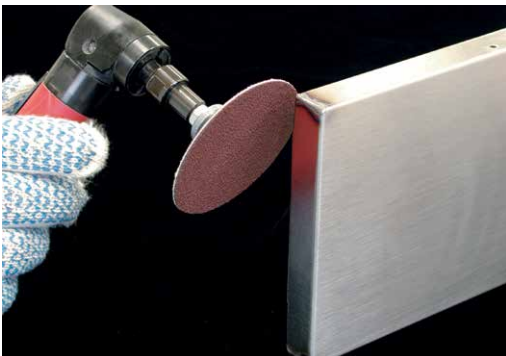

Size	Grit	SAIT-LOK™ Part No.		SAIT-LOK-R™ Part No.		Qty Per Box
		Z	3Z	Z	3Z	
1-1/2"	36	55215	56215	55264	56264	100
	40	55216	-	55265	-	100
	50	55217	56217	55266	56266	100
	60	55218	56218	55267	56267	100
	80	55219	56219	-	56268	100
2"	24	55221	-	55270	-	100
	36	55222	56222	55271	56271	100
	40	55223	-	55272	-	100
	50	55224	56224	55273	56276	100
	60	55225	56225	55274	56274	100
3"	80	55226	56226	55275	56275	100
	24	55228	-	55277	-	50
	36	55229	56229	55278	56278	50
	40	55230	-	55279	-	50
	50	55231	56231	55280	56280	50
60	55232	56232	55281	56281	50	
80	55233	56233	55282	56282	50	

Tech INFO

- 2-ply construction is rugged enough for contour surfaces or flat surfaces
- Quick-change backings make for fast, easy disc changes and less downtime
- Universal backings fit most major backing pad brands on the market

FLAP WHEELS

Small Diameter



Die Grinder

Mat'l	Size		Grit	Part Number	
	Dia.	Width		1/4	1/4-20 Threaded
2A General purpose aluminum oxide	1	3/4	60	70001	71000
	1	3/4	80	70002	71001
	1	3/4	120	70003	71002
	1	3/4	180	70004	71003
	1	3/4	240	70005	71004
	1	1	60	70010	71010
	1	1	80	70011	71011
	1	1	120	70012	71012
	1	1	180	70013	71013
	1	1	240	70014	71014
	1-1/2	1/2	40	70024	-
	1-1/2	1/2	60	70025	71020
	1-1/2	1/2	80	70026	71021
	1-1/2	1/2	120	70027	71022
	1-1/2	1/2	180	70028	71023
	1-1/2	1/2	240	70029	71024
	1-1/2	1	60	70040	71030
	1-1/2	1	80	70041	71031
	1-1/2	1	120	70042	71032
	1-1/2	1	180	70043	71033
	1-1/2	1	240	70044	71034
	2	1	40	70049	-
	2	1	60	70050	71040
	2	1	80	70051	71041
	2	1	120	70052	71042
	2	1	180	70053	71043
	2	1	240	70054	71044
	2-1/2	1/2	60	70060	71050
	2-1/2	1/2	80	70061	71051
	2-1/2	1/2	120	70062	71052
	2-1/2	1/2	180	70063	71053
	2-1/2	1/2	240	70064	71054
	2-1/2	1	40	70069	-
	2-1/2	1	60	70070	71055
	2-1/2	1	80	70071	71056
	2-1/2	1	120	70072	71057
	2-1/2	1	180	70073	71058
	2-1/2	1	240	70074	71059
	3	1/2	60	70080	71060
	3	1/2	80	70081	71061
3	1/2	120	70082	71062	
3	1/2	180	70083	71063	
3	1/2	240	70084	71064	
3	3/4	60	70090	71070	
3	3/4	80	70091	71071	
3	3/4	120	70092	71072	
3	3/4	180	70093	71073	
3	3/4	240	70094	71074	
3	1	40	70099	-	
3	1	60	70100	71080	
3	1	80	70101	71081	
3	1	120	70102	71082	
3	1	180	70103	71083	
3	1	240	70104	71084	
3	2	40	70110	-	
3	2	60	70111	-	
3	2	80	70112	-	
3	2	120	70113	-	
3A Aluminum Oxide with grinding aid	2	1	60	74050	71160
	2	1	80	74051	71161
	2	1	120	74052	71162
	2-1/2	1	60	74060	71170
	2-1/2	1	80	74061	71171
	2-1/2	1	120	74062	71172
	3	1	60	74070	71180
	3	1	80	74071	71181
3	1	120	74072	-	

Aluminum Oxide 2A

- Premium aluminum oxide grain
- **General purpose**
- Excellent for cleaning, deburring, polishing, blending

METAL Ferrous and/or non-ferrous metals (iron, steel, aluminum, copper, etc.)

WOOD Wood, plastic, fiberglass, etc.

Aluminum Oxide with Grinding Aid 3A

- Premium aluminum oxide grain with grinding aid
- **Excellent for reducing heat build-up on heat sensitive materials**
- Excellent for cleaning, deburring, polishing, blending

STAINLESS Stainless steel, high tensile steel, titanium

METAL Ferrous and/or non-ferrous metals

Straight 1/4" and threaded 1/4-20 mandrels available
See page 146 for 1/4-20 adapter

Packaging
10/box



COATED ABRASIVES

FLAP WHEELS



- Resin over resin construction for a strong bond resistant to heat and moisture
- Closed coat structure for more material removal
- High quality Egyptian cotton cloth backing provides superior durability
- UPC bar coded labeled boxes for easy identification and inventory maintenance

Large Diameter

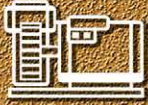

Pedestal Grinder



Angle Grinder

FLAP WHEELS

Aluminum Oxide 2A

- Premium aluminum oxide grain
- **General purpose**
- Excellent for cleaning, deburring, polishing, blending

METAL Ferrous metals

ALUMINUM Non-ferrous metals

WOOD Wood, plastic, fiberglass, etc.



Aluminum Oxide 3A with Grinding Aid

- Premium aluminum oxide grain with grinding aid
- **Excellent for reducing heat build-up on heat sensitive materials**
- Excellent for cleaning, deburring, polishing, blending

STAINLESS Stainless steel, high tensile steel, titanium

ALUMINUM Non-ferrous metals

METAL Ferrous metals



Threaded Flap Wheel (5/8-11 for Right Angle Grinder)

- For use on standard 4-1/2" and 5" angle grinders
- **Applies a linear scratch pattern, instead of a swirl; narrow profile is excellent for cleaning weld beads**
- Suitable for surface preparation, paint and rust removal, cleaning, and finishing
- Increases the versatility of your angle grinder

STAINLESS Stainless steel, high tensile steel, titanium

METAL Ferrous materials

ALUMINUM Non-ferrous materials

Mat'l	Size			Max RPM	Grits Available	Part No.
	Dia.	Width	Spindle			
2A Premium aluminum oxide	6	1	1	6,000	60	72000
	6	1	1	6,000	80	72001
	6	1	1	6,000	100	72002
	6	1	1	6,000	120	72003
	6	1-1/2	1	6,000	60	72020
	6	1-1/2	1	6,000	80	72021
	6	1-1/2	1	6,000	120	72023
	6	2	1	6,000	60	72030
	6	2	1	6,000	80	72031
	6	2	1	6,000	100	72032
	6	2	1	6,000	120	72033
	8	1	1	4,400	60	72040
	8	1	1	4,400	80	72041
	8	1	1	4,400	120	72043
	8	2	1	4,400	60	72050
	8	2	1	4,400	80	72051
	8	2	1	4,400	120	72053
	3A Premium aluminum oxide with grinding aid	6	1	1	6,000	60
6		1	1	6,000	80	72006
6		1	1	6,000	120	72008
6		1-1/2	1	6,000	60	72025
6		1-1/2	1	6,000	80	72026
6		2	1	6,000	60	72035
6		2	1	6,000	80	72036
6		2	1	6,000	120	72038

Packaging
6" - 5/box
8" - 3/box

Dia.	Size		Max RPM	Grits Available	Part No.
	Width	Arbor			
4-1/2	3/4	5/8-11	13,300	40	72130
4-1/2	3/4	5/8-11	13,300	60	72132
4-1/2	3/4	5/8-11	13,300	80	72133
4-1/2	3/4	5/8-11	13,300	120	72135
5	3/4	5/8-11	12,200	40	72140
5	3/4	5/8-11	12,200	60	72142
5	3/4	5/8-11	12,200	80	72143
5	3/4	5/8-11	12,200	120	72145

Packaging
5/box

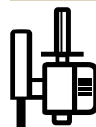

For use on a
Right Angle Grinder



Quick Tip

Slower speeds = better flap wheel performance and life.

See page 146 for:
1/4" shank adapter kit - #95009



- Resin over resin construction for a strong bond resistant to heat and moisture
- Closed coat structure for more material removal
- High quality Egyptian cotton cloth backing provides superior durability
- Label UPC bar coded for easy identification and inventory maintenance

FLAP WHEELS

COATED ABRASIVES

SHEETS



- Full product offering of cloth and paper sheets in a variety of sizes and materials to fit your needs.
- Whether you are working by hand or with mechanical assistance, these products are sure to exceed your expectations.



Ultimate Performance Paper Sheets (pg. 104-105):

- Highest quality industrial paper.
- Available in:
 - Aluminum oxide (AW-C and AW-D)
 - Premium stearate aluminum oxide (4S)
 - Stearate aluminum oxide (3S)
 - Silicon carbide (CW-C)
 - Garnet



Premium Cloth 9 X 11 sheets (pg. 104):

- SAIT DA-F Cloth Sheet
 - Very flexible while maintaining the highest durability.
 - Open coat design.
- SAIT EA-S Cloth Sheet
 - Tear-resistant and non-loading.
 - Great for hand sanding wood, aluminum, and painted surfaces.



Saitscreen™ 9 X 11 sheets (pg. 106):

- Cloth screen impregnated with silicon carbide grain.
- Non-loading, wet/dry design.



Dry Wall Sheets (pg. 106):

- Premium products to fit plaster and dry wall joint applications.
- Available in Saitscreen™ cloth screen and silicon carbide paper sheets and rolls.



Sponges (pg. 107):

- Premium quality sanding sponges for top performance.
- Available in: • 1" sanding blocks • 1/2" fabric reinforced • 5mm contour pads



Hand Sanding

Cloth Sheets



Aluminum Oxide (DA-F)

- Aluminum oxide grain on a flexible cloth backing
- Open coat structure prevents loading
- Long life combined with excellent stock removal
- **Excellent for woodworking applications**

WOOD Wood, plastic, fiberglass

METAL Ferrous and/or non-ferrous materials (iron, steel, copper, etc.)

- Available in F-weight - high flexibility

Stearate Aluminum Oxide (EA-S)

- Aluminum oxide grain on a flexible tear-resistant cloth backing
- **Stearate coating and open coat structure lubricates and prevents loading**
- **Excellent for hand sanding wood, aluminum, and painted surfaces**

WOOD Wood, plastic, fiberglass

METAL Ferrous and/or non-ferrous materials (iron, steel, copper, etc.)

- Available in F-weight - high flexibility

Aluminum Oxide

Size	Grit	DA-F Part No.	EA-S Part No.	Std Pkg.
9 x 11	36	84907	-	25
	40	84908	-	25
	50	84909	-	25
	60	84910	-	25
	80	84911	-	25
	100	84912	-	50
	120	84913	84160	50
	150	84914	84161	50
	180	84915	84162	50
	220	84916	84163	50
	240	84917	-	50
	320	84918	84166	50
	400	-	84167	50

COATED ABRASIVES

Paper Sheets



Aluminum Oxide

Size	Grit Wgt.	Part No.	Std Pkg.
9 x 11 AW-D	40D	84211	100
	50D	84212	100
	60D	84213	100
	80D	84214	100
	100D	84215	100
	120D	84216	100
9 x 11 AW-C	150C	84200	100
	180C	84201	100
	220C	84202	100
	240C	84203	100
	320C	84204	100
	400C	84205	100
	500C	84206	100
	600C	84207	100
	800C	84208	100
	1200C	84209	100
9 x 11 Garnet	50D	84101	50
	60C	84102	50
	80C	84103	50
	100C	84104	100
	120C	84105	100
	180A	84107	100
220A	84108	100	

Aluminum Oxide (AW-C & AW-D)

- Extremely long lasting
- Open coat structure prevents loading
- Use wet or dry

WOOD Wood, sealers, fillers

METAL Ferrous and/or non-ferrous metals

- **Available in grits up to 1200 for ultra fine finishing**
- Available in weights: "C"-medium weight, medium flexibility
"D"-heavy weight, low flexibility

Garnet

- Natural garnet grain
- Open coat structure prevents loading
- Use dry only

WOOD Soft woods

- Available in weights: "A"-light weight, high flexibility
"C"-medium weight, medium flexibility
"D"-heavy weight, low flexibility

SHEETS

Tech
INFO

- Resin over resin construction for a strong bond resistant to heat and moisture
- Cloth backing for durability and flexibility
- Box label UPC bar coded for easy identification and inventory maintenance
- Our highest quality industrial paper for extra durability on all applications
- Broad assortment of grit sizes for a wide range of sanding and finishing applications
- Strong resin over resin bond construction is resistant to heat and moisture



Premium Stearate Aluminum Oxide (4S)

- Premium aluminum oxide
- **Stearate coating and open coat structure lubricates and prevents loading**
- Long lasting performance and fast removal rates for fine finishing of automotive body works and wood finishing
- Use dry only
- Available in C-weight - medium weight, low flexibility

WOOD Body filler, paint, fiberglass, wood and fiberglass

METAL Ferrous and non-ferrous metals



Stearate Aluminum Oxide (3S)

- Extremely long lasting
- **Open coat structure prevents loading**
- Use dry only

WOOD Sealers, body filler, paint, fiberglass, wood

METAL Aluminum

- Available in grits up to 500 for fine finishing
- Available in C-weight - medium weight, medium flexibility

Stearate Aluminum Oxide

Size	Grit Wgt.	Part No.		Std Pkg.
		3S	4S	
9 x 11	80C	84230	84283	100
	100C	84231	84284	100
	120C	84232	84285	100
	150C	84233	84286	100
	180C	84234	84287	100
	220C	84235	84288	100
	240C	84236	84289	100
	320C	84237	84290	100
	400C	84238	84291	100
	500C	84239	84292	100
	600C	-	84293	100

Waterproof

Silicon Carbide (CW-C)

- Extremely long lasting
- **Closed coat structure for more material removal**
- Use wet or dry

WOOD Varnish, plastic, fiberglass, clear coat, primer

CONCRETE Marble, ceramics

METAL Ferrous and/or non-ferrous metals

- Available in grits up to 2000 for ultra fine finishing
- Available in C-weight - medium weight, medium flexibility

Waterproof Silicon Carbide

Size	Grit Wgt.	Part No.	Std Pkg.
9 x 11 CW-C	80C	84249	100
	100C	84250	100
	120C	84251	100
	150C	84252	100
	180C	84253	100
	220C	84254	100
	240C	84255	100
	320C	84256	100
	400C	84257	100
	500C	84258	100
	600C	84259	100
	800C	84260	100
1200C	84261	100	
5-1/2 x 9 CW-C	1000C	84270	50
	1200C	84271	50
	1500C	84274	50
	2000C	84277	50

SAIT-PAK™ 9" x 11" Sheets

- Packaged in smaller, easy-to-sell quantities.
- Specifically geared to customers desiring more consumer-oriented packaging: skilled craftsmen, professional tradesmen, MRO engineers, fabricators, and the knowledgeable do-it-yourselfer.



All Purpose Aluminum Oxide Sheets

Part No	Grade/Grit	Sheets Per Pkg	Pkgs Per Unit
10012	Very Fine - 220	5	5
10010	Fine - 150	5	5
10008	Medium - 100	5	5
10006	Coarse - 60	3	5
10015	Assorted: 2 Very Fine, 2 Fine, 1 Medium	5	5

Waterproof Silicon Carbide Sheets

Part No	Grade/Grit	Sheets Per Pkg	Pkgs Per Unit
10034	Ultra Fine - 600	5	5
10032	Super Fine - 400	5	5
10031	Extra Fine - 320	5	5
10028	Very Fine - 220	5	5
10036	Assorted: 2 Super Fine, 2 Extra Fine, 1 Very Fine	5	5

COATED ABRASIVES

SHEETS



Saitscreen™

- Strong cloth screen impregnated with silicon carbide grain
- Open coat structure prevents loading
- Use wet or dry
- **Extremely long lasting**
- Double sided and die cut

WOOD Plaster, dry wall joints

Paper

- Aluminum oxide grain
- Paper backing
- Open coat structure prevents loading
- Use dry
- **Provides a smooth finish**
- Easy-to-handle rolls for on-the-job "cut to size" use

WOOD Plaster, dry wall joints

Saitscreen™ 9 x 11 Sheets

- Cloth screen impregnated with silicon carbide grain
- Use wet or dry
- Non-loading
- **Strong, long lasting**

WOOD Body filler, paint, fiberglass

CONCRETE Ceramic, marble, cement

METAL Ferrous and/or non-ferrous metals



Size	Grit Wgt.	Part No.	Std Pkg.
Saitscreen™	80	84070	50
4-3/16 x 11	100	84071	50
Diecut	220	84075	50
	80C	84066	100
Paper	100C	84067	100
3-5/16 x 11	120C	84068	100
	150C	84069	100
Paper	80C	84051	100
4-3/16 x 11	100C	84050	100
Diecut	120C	84052	100
	150C	84053	100
Paper	80C	84056	1
3-5/16	100C	84057	1
x 50 yds.	120C	84058	1
	150C	84059	1
	80	84076	25
Saitscreen™	100	84077	25
9 x 11	120	84078	25
	150	84079	25

**Tech
INFO**

- Available in screen or paper sheets offering the best product for your application
- Open coat structures on both backings prevents clogging and loading in extreme applications

SPONGES & SHEETS



Sanding Sponges

- Premium abrasive grain on a soft, foam backing
- Foam backing provides ultimate conformability and is washable for long life
- For use on wood moldings, metal contours, drywall sanding, and paint removal applications

WOOD Hardwoods and softwoods, plastic, paint fiberglass, auto body filler, and drywall compounds

METAL Ferrous and/or non-ferrous metals



Note: Sponges are double sided

Hi-Density Sanding Block

Contour Sanding Pad

Fabric Reinforced Sanding Pad

Size	Grit Available	Part Nos.	Qty Per Box
1"	60	86355	24
	80	86356	24
	100	86357	24
	120	86359	24
	180	86360	24
5 mm	60	86445	100
	100	86447	100
	180	86450	100
	280	86451	100
1/2"	60	86475	24
	100	86477	24
	150	86479	24
	180	86480	24
	220	86481	24

Aluminum Oxide clip-on Fileboard Sheets

- Aluminum oxide grain
- Open coat structure prevents loading

WOOD Auto body filler, paint & fiberglass

METAL Ferrous and/or non-ferrous metals



Size	Grit Wgt.	Part No.	Std Pkg.
Aluminum Oxide 2-3/4 x 17-1/2	36D	84170	50
	40D	84171	50
	60D	84172	100
	80D	84173	100
	100C	84174	100



- Sanding sponges can be used wet or dry for fine finishing and can be washed to extend cutting life (just wash with water)
- In general, the finish of sanding sponges will be finer than traditional coated abrasives
- Due to the ability to conform to different shapes, sanding sponges are able to sand and finish in hard to reach areas

COATED ABRASIVES

SHEETS



Industrial Rolls - EA-F

- Aluminum oxide grain
- Premium quality EA-F material for very high flexibility
- High tensile strength, extra durable backing
- Long life
- **Primarily for machine applications**

METAL Ferrous and/or non-ferrous metals (iron, aluminum, copper, normal and high tensile steel)

WOOD Wood, fiberglass, etc.

Handy Rolls - DA-F

- Aluminum oxide grain
- High quality DA-F material for high flexibility
- Medium tensile strength
- **Primarily for hand applications**

METAL Ferrous and/or non-ferrous materials (iron, aluminum, copper, normal and high tensile steel)

WOOD Wood, fiberglass, etc.



COATED
ABRASIVES

SHOP ROLLS

Packaging
50 yd length, 1/box

EA-F Industrial Rolls		Size Width	Grit	Part No.
1"			40	80415
			50	80515
			60	80615
			80	80815
			100	81015
			120	81215
			150	81515
			180	81815
			220	82215
			240	82415
			320	83215
			400	83415
1-1/2"			40	80416
			50	80516
			60	80616
			80	80816
			100	81016
			120	81216
			150	81516
			180	81816
			220	82216
			240	82416
			320	83216
			400	83416
2"			40	80430
			50	80530
			60	80630
			80	80830
			100	81030
			120	81230
			150	81530
			180	81830
			220	82230
			240	82430
			320	83230
			400	83430

DA-F Handy Rolls		Size Width	Grit	Part No.
1"			40	80405
			50	80505
			60	80605
			80	80805
			100	81005
			120	81205
			150	81505
			180	81805
			220	82205
			240	82405
			320	83205
			400	83405
1-1/2"			40	80406
			50	80506
			60	80606
			80	80806
			100	81006
			120	81206
			150	81506
			180	81806
			220	82206
			240	82406
			320	83206
			400	83406
2"			40	80420
			50	80520
			60	80620
			80	80820
			100	81020
			120	81220
			150	81520
			180	81820
			220	82220
			240	82420
			320	83220
			400	83420



- Resin over resin construction for a strong bond resistant to heat and moisture
- Egyptian cotton cloth backing for superior durability
- Available in 2 tensile strengths for a wide range of applications
- Open coat structure prevents loading
- Box label UPC bar coded for easy identification and inventory maintenance



DA-F Mini Shop Rolls

- Aluminum oxide grain
- DA-F material for high flexibility
- Open coat structure prevents loading
- For hand applications

- METAL** Ferrous and/or non-ferrous materials
- WOOD** Wood, fiberglass, etc.

Packaging
10 yard lengths

DA-F Mini Shop Rolls

Size	Grit	Part No.
1-1/2" x 10 yds.	60	80607
	80	80807
	120	81207
	180	81807



EA-F Custom Rolls

- Premium quality EA-F material for very high flexibility used in industrial rolls
- Open coat structure prevents loading

- METAL** Ferrous and/or non-ferrous materials
- WOOD** Wood, fiberglass, etc.

Can be slit up to 3 cuts, 3" minimum width
Specify widths when ordering

Packaging
50 yard lengths

EA-F Custom Rolls

Size Width	Grit	Part No.
12"	40	81640
	50	81650
	60	81660
	80	81680
	100	81610
	120	81612
	150	81615
	180	81618
	220	81622
	240	81624
	320	81632
	400	81604

Tech INFO

- Resin over resin construction for a strong bond resistant to heat and moisture
- Egyptian cotton cloth backing for superior durability
- Available in 2 tensile strengths for a wide range of applications
- Open coat structure prevents loading
- Box label UPC bar coded for easy identification and inventory maintenance

COATED ABRASIVES

SHOP ROLLS



Rolls

Saitscreen™ Rolls

- Silicon carbide grain
- Long life
- Waterproof
- **Non-loading screen cloth**

METAL Ferrous and/or non-ferrous metals (steel, solder, copper)

CONCRETE Ceramic

WOOD Wood, paint, etc.



Individually packaged rolls

Saitscreen™ Rolls

Size Width	Grit	Part No.
1-1/2" x 5 yds.	80	84089
	120	84092
	180	84095
1-1/2" x 10 yds.	80	84090
	120	84093
	180	84096
1-1/2" x 25 yds.	80	84091
	120	84094
	180	84097

Plumber Rolls

- Aluminum oxide grain
- Open coat structure prevents loading
- Use dry only
- **Excellent for cleaning pipe ends**

METAL Ferrous and/or non-ferrous materials, copper piping



Packaged 1/box

Plumber Rolls

Size Width	Grit	Part No.
1-1/2" x 25 yds	120	80000

AW-D Mini Paper Rolls

- Aluminum oxide grain
- Open coat structure prevents loading
- For wet or dry hand operations

WOOD Wood, paint, etc.

PAINT Body filler, paint, primers

METAL Ferrous and/or non-ferrous metals



Packaged 10/box



Mini Paper Rolls

Size Width	Grit	Part No.
4-1/2" x 5 yds	40	81101
	60	81102
	80	81103
	100	81104
	120	81105
	150	81106
	180	81107
	220	81108

Tech
INFO

Saitscreen™ Rolls

- Double sided for long life
- Box label UPC bar coded for easy identification and inventory maintenance

Plumber Rolls

- Box label UPC bar coded for easy identification and inventory maintenance
- Cloth backed for durability and flexibility



Die Grinder

Aluminum Oxide - General Purpose

Premium Aluminum Oxide Grain

- Excellent for removing parting lines, imperfections, and burrs on all surfaces
- Great in curved, corner, contoured, and hard to reach areas

METAL Ferrous and/or non-ferrous metals

STAINLESS Stainless steel, high tensile steel, wood

See page 147 for Drums



Spiral Bands

Size	Grit	Max RPM	Part Nos.	Qty Per Box
1/2 x 1/2	60	30,000	42001	100
	80	30,000	42002	100
	120	30,000	42003	100
1/2 x 1	60	15,000	42006	100
	80	15,000	42007	100
	120	15,000	42008	100
1/2 x 1-1/2	60	12,000	42011	100
	80	12,000	42012	100
	120	12,000	42013	100
3/4 x 1	36	19,000	42016	100
	60	19,000	42017	100
	80	19,000	42018	100
	120	19,000	42019	100
3/4 x 1-1/2	60	10,000	42022	100
	80	10,000	42023	100
	120	10,000	42024	100
1 x 1	36	18,000	42027	100
	60	18,000	42028	100
	80	18,000	42029	100
	120	18,000	42030	100
1-1/2 x 1	36	14,000	42033	100
	60	14,000	42034	100
	80	14,000	42035	100
	120	14,000	42036	100
1-1/2 x 1-1/2	36	10,000	42039	100
	60	10,000	42040	100
	80	10,000	42041	100
	120	10,000	42042	100
2 x 2	36	6,000	42045	50
	60	6,000	42046	50
	80	6,000	42047	50
	120	6,000	42048	50
3 x 3	36	3,000	42051	50
	60	3,000	42052	50
	80	3,000	42053	50
	120	3,000	42054	50



COATED ABRASIVES

SPECIALTIES



- Single ply of coated abrasive, spirally wound and bonded to an inner liner
- Quick removal and installation
- Smooth running for ease of use and control

Cartridge Rolls



Die Grinder

SPECIALTIES

Aluminum Oxide - Straight

Premium Aluminum Oxide Grain

- Excellent for sanding and polishing channels, fillets, recesses, side walls, and bottoms of dead-end holes
- Great for high speed deburring and flash removal

METAL Ferrous and/or non-ferrous metals

STAINLESS Stainless steel, high tensile steel

Packaging 100/box

See page 147 for Cartridge Roll mandrels

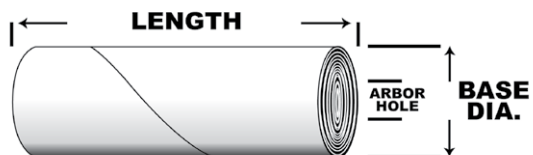

Size B x L x A	Grit	Max RPM	Cartridge Roll Part Nos.	Mandrel Part Nos.
3/16 x 1 x 3/32	80	26,000	38001	95108
	120	26,000	38003	95108
1/4 x 1 x 1/8	60	26,000	38007	95105
	80	26,000	38008	95105
	120	26,000	38010	95105
1/4 x 1-1/2 x 1/8	320	26,000	38013	95105
	60	26,000	38014	95104
	80	26,000	38015	95104
3/8 x 1 x 1/8	120	26,000	38017	95104
	240	26,000	38019	95104
	60	26,000	38040	95105
3/8 x 1-1/2 x 1/8	80	26,000	38041	95105
	120	26,000	38043	95105
	50	26,000	38047	95104
3/8 x 1-1/2 x 1/8	60	26,000	38048	95104
	80	26,000	38049	95104
	120	26,000	38051	95104
3/8 x 2 x 1/8	60	26,000	38055	95103
	80	26,000	38056	95103
	50	26,000	38062	95105
1/2 x 1 x 1/8	60	26,000	38063	95105
	80	26,000	38064	95105
	120	26,000	38066	95105

Size B x L x A	Grit	Max RPM	Cartridge Roll Part Nos.	Mandrel Part Nos.
1/2 x 1-1/2 x 1/8	36	26,000	38070	95104
	40	26,000	38071	95104
	50	26,000	38072	95104
	60	26,000	38073	95104
	80	26,000	38074	95104
1/2 x 2 x 1/8	120	26,000	38076	95104
	60	26,000	38080	95103
	80	26,000	38081	95103
1/2 x 2 x 3/16	120	26,000	38083	95103
	60	26,000	38087	95106
	80	26,000	38088	95106
5/8 x 1-1/2 x 1/8	120	26,000	38089	95106
	60	18,000	38093	95104
	80	18,000	38094	95104
3/4 x 1-1/2 x 3/16	120	18,000	38095	95104
	40	18,000	38112	95107
	60	18,000	38113	95107
3/4 x 2 x 3/16	80	18,000	38114	95107
	40	18,000	38119	95106
	60	18,000	38120	95106
1 x 1-1/2 x 1/4	80	18,000	38121	95106
	120	18,000	38122	95106
	60	18,000	38126	95102
1 x 2 x 1/4	80	18,000	38127	95102
	120	18,000	38128	95102
	60	18,000	38132	95101
1 x 2 x 1/4	80	18,000	38133	95101
	120	18,000	38134	95101



- Multi-layer, self dressing construction - exposes sharp, new cutting abrasive as each layer wears away
- Available in straight and full taper designs - long lasting performance
- Quick removal and installation - less downtime



Die Grinder

Aluminum Oxide - Full Taper

Premium Aluminum Oxide Grain

- Excellent for sanding and polishing channels, fillets, recesses, side walls, and bottoms of dead-end holes
- Great for high speed deburring and flash removal

METAL Ferrous and/or non-ferrous metals

STAINLESS Stainless steel, high tensile steel

Packaging

100/box

See page 147 for Cartridge Roll mandrels

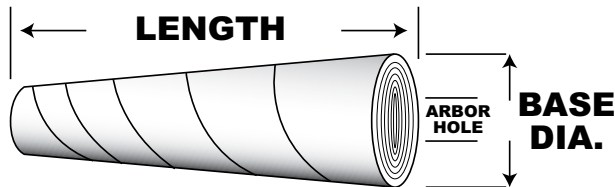

Base Dia.	Size		Grit	Max RPM	Cartridge Roll Part Nos.	Mandrel Part Nos.
	Length	Arbor Hole				
3/8	1	1/8	60	26,000	38300	95105
3/8	1	1/8	80	26,000	38301	95105
3/8	1	1/8	120	26,000	38302	95105
3/8	1-1/2	1/8	60	26,000	38306	95104
3/8	1-1/2	1/8	80	26,000	38307	95104
3/8	1-1/2	1/8	120	26,000	38308	95104
1/2	1	1/8	60	26,000	38312	95105
1/2	1	1/8	80	26,000	38313	95105
1/2	1	1/8	120	26,000	38314	95105
1/2	1-1/2	1/8	50	26,000	38318	95104
1/2	1-1/2	1/8	60	26,000	38319	95104
1/2	1-1/2	1/8	80	26,000	38320	95104
1/2	1-1/2	1/8	120	26,000	38322	95104
1/2	2	1/8	60	26,000	38326	95103
1/2	2	1/8	80	26,000	38327	95103
1/2	2	1/8	120	26,000	38328	95103
5/8	2	1/8	60	18,000	38332	95103
5/8	2	1/8	80	18,000	38333	95103
3/4	1-1/2	1/8	60	18,000	38338	95104
3/4	1-1/2	1/8	80	18,000	38339	95104
3/4	1-1/2	1/8	120	18,000	38340	95104
3/4	2	3/16	60	18,000	38344	95106
3/4	2	3/16	80	18,000	38345	95106
3/4	2	3/16	120	18,000	38346	95106

COATED ABRASIVES

SPECIALTIES

Tech INFO

- Multi-layer, self dressing construction - exposes sharp, new cutting abrasive as each layer wears away
- Available in straight and full taper designs - long lasting performance
- Quick removal and installation - less downtime



Die Grinder

Cross Pads

Size	Mandrel Size	Grit	Recommended RPM Range	Max RPM	Part No.	Qty Per Box
1 x 3/8	3-48	60	20,000-23,000	25,000	48036	50
	3-48	80	20,000-23,000	25,000	48037	50
	3-48	120	20,000-23,000	25,000	48038	50
1-1/2 x 1/2	8-32	60	19,000-20,000	23,000	48041	50
	8-32	80	19,000-20,000	23,000	48042	50
	8-32	60	19,000-20,000	23,000	48046	50
2 x 1/2	8-32	80	19,000-20,000	23,000	48047	50
	8-32	120	19,000-20,000	23,000	48048	50
	1/4-20	60	19,000-20,000	23,000	48051	50
2 x 1	1/4-20	80	19,000-20,000	23,000	48052	50
	1/4-20	120	19,000-20,000	23,000	48053	50
	1/4-20	60	10,000-12,000	14,000	48056	50
3 x 1	1/4-20	80	10,000-12,000	14,000	48057	50
	1/4-20	120	10,000-12,000	14,000	48058	50
	1/4-20	60	9,000-10,000	14,000	48061	50
4 x 1	1/4-20	80	9,000-10,000	14,000	48062	50
	1/4-20	120	9,000-10,000	14,000	48063	50

Aluminum Oxide - General Purpose Premium Aluminum Oxide Grain

- Excellent for deburring tubing, blending radii, polishing inside contours, and polishing and finishing bell-mouth configurations, drop forge and Kirksite dies

- METAL** Ferrous and/or non-ferrous metals
- STAINLESS** Stainless steel, high tensile steel



See page 147 for mandrels

Square Pads

Size	Mandrel Size	Grit	Recommended RPM Range	Max RPM	Part No.	Qty Per Box
1-1/2 x 1/2	1/4-20	60	19,000-20,000	23,000	48006	50
	1/4-20	80	19,000-20,000	23,000	48007	50
	1/4-20	120	19,000-20,000	23,000	48008	50
2 x 1/4	8-32	60	19,000-20,000	23,000	48011	50
	8-32	80	19,000-20,000	23,000	48012	50
	1/4-20	60	19,000-20,000	23,000	48016	50
2 x 1/2	1/4-20	80	19,000-20,000	23,000	48017	50
	1/4-20	120	19,000-20,000	23,000	48018	50
	1/4-20	60	19,000-20,000	23,000	48021	50
2 x 3/4	1/4-20	80	19,000-20,000	23,000	48022	50
	1/4-20	60	10,000-12,000	14,000	48026	50
	1/4-20	80	10,000-12,000	14,000	48027	50
3 x 1/4	1/4-20	120	10,000-12,000	14,000	48028	50
	1/4-20	60	10,000-12,000	14,000	48031	50
	1/4-20	80	10,000-12,000	14,000	48032	50
3 x 1/2	1/4-20	120	10,000-12,000	14,000	48033	50

Aluminum Oxide - General Purpose Premium Aluminum Oxide Grain

- Excellent for grinding and blending on channels, fillets and corners, spotting on flat surfaces, and blending welds inside of pipes

- METAL** Ferrous and/or non-ferrous metals
- STAINLESS** Stainless steel, high tensile steel, wood



- Multi-ply abrasive pad - exposes new cutting surface as each layer wears
- Cushioned, chatter free grinding and polishing for long lasting performance



Sheets

Grits 12-20

- Silicon carbide grain
- Combination backing paper and cloth
- Open coat structure prevents loading
- **Excellent for removing heavy finishes**

WOOD Wood

Grits 36-100

- Silicon carbide grain
- Closed coat for more material removal
- **Excellent for general refinishing**

WOOD Wood

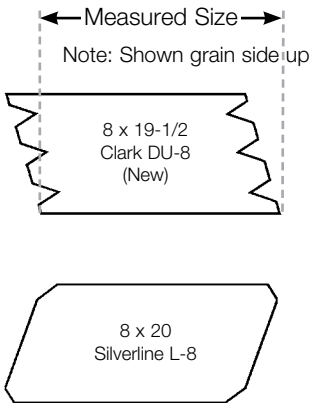

Size	Grit Available		Part Nos.	Qty Per Box
	New Grit	Old Grit		
8 x 19-1/2	16	4	85000	50
	20	3-1/2	85001	50
	36	2	85002	50
	40	1-1/2	85003	50
	60	1/2	85004	50
	80	0	85005	50
8 x 20	100	2/0	85006	50
	16	4	85007	50
	20	3-1/2	85008	50
	36	2	85009	50
	40	1-1/2	85010	50
	60	1/2	85011	50
	80	0	85012	50
	100	2/0	85013	50

There are 2 grit grading systems for abrasive floor paper. Both systems appear in the table at left.



COATED ABRASIVES

Belts - Cloth

Grits 36-120

- Premium zirconium grain for high stock removal and long life
- Belt design allows for quick changing of abrasive materials

WOOD Wood floors

Size	Grit Available	Part Nos.	Qty Per Box
8 x 19 AZ-X Zirconium	36	85285	10
	50	85286	10
	60	85287	10
	80	85288	10
	120	85289	10

**Tech
INFO**

- Professional quality for use in tough industrial jobs
- Shrink wrapped for easy handling and long life
- Box label UPC bar coded for easy identification and inventory maintenance

FLOOR SANDING

Sanding Discs

FLOOR SANDING



Edge Sander



Floor Sander

Grits 12-20

- Silicon carbide grain
- Combination backing paper and cloth
- Open coat structure prevents loading
- **Excellent for removing heavy finishes**

WOOD Wood

Grits 36-100

- Silicon carbide grain
- Closed coat for more material removal
- **Excellent for general refinishing**

WOOD Wood

There are 2 grit grading systems for abrasive floor paper. Both systems appear in the table.

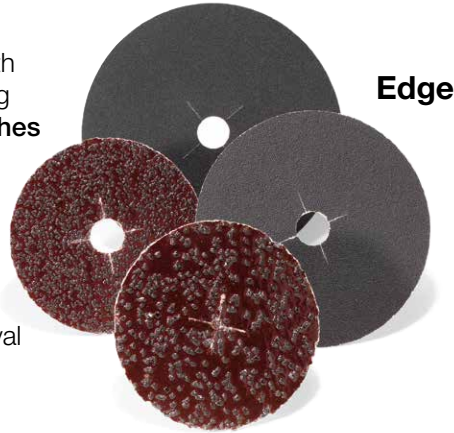

Edge

Lg. Dia.

Size	Grit Available		Part Nos.	Qty Per Box	
	New Grit	Old Grit			
5 x 1/4	12	4-1/2	85230	20	
	16	4	85231	20	
	20	3-1/2	85232	20	
	36	2	85233	20	
	40	1-1/2	85234	20	
	60	1/2	85235	25	
	80	0	85236	25	
	100	2/0	85237	25	
	7 x 7/8	12	4-1/2	85219	20
		16	4	85220	20
20		3-1/2	85221	20	
36		2	85222	20	
40		1-1/2	85223	20	
60		1/2	85224	25	
80		0	85225	25	
100		2/0	85226	25	
15 x 2		12	4-1/2	85121	20
		16	4	85100	20
	20	3-1/2	85101	20	
	36	2	85102	20	
	40	1-1/2	85103	20	
	60	1/2	85104	25	
	80	0	85105	25	
	100	2/0	85106	25	
	16 x 2	12	4-1/2	85122	20
		16	4	85107	20
20		3-1/2	85108	20	
36		2	85109	20	
40		1-1/2	85110	20	
60		1/2	85111	25	
80		0	85112	25	
100		2/0	85113	25	
17 x 2		12	4-1/2	85123	20
		16	4	85114	20
	20	3-1/2	85115	20	
	36	2	85116	20	
	40	1-1/2	85117	20	
	60	1/2	85118	25	
	80	0	85119	25	
	100	2/0	85120	25	
	18 x 2	12	4-1/2	85130	20
		16	4	85131	20
20		3-1/2	85132	20	
36		2	85133	20	
40		1-1/2	85134	20	
60		1/2	85135	25	
80		0	85136	25	
100		2/0	85137	25	
20 x 2		12	4-1/2	85140	20
		16	4	85141	20
	20	3-1/2	85142	20	
	36	2	85143	20	
	40	1-1/2	85144	20	
	60	1/2	85145	25	
	80	0	85146	25	
	100	2/0	85147	25	

COATED ABRASIVES

FLOOR SANDING

Tech
INFO

- Professional quality for use in tough industrial jobs
- Shrink wrapped for easy handling and long life

FLOOR SANDING Rolls & Saitscreen™



Floor Sander



Grits 12-20

- Silicon carbide grain
- Combination backing paper and cloth
- Open coat structure prevents loading
- **Excellent for removing heavy finishes**

WOOD Wood floors

Grits 36-100

- Silicon carbide grain
- Closed coat for more material removal
- **Excellent for general refinishing**

WOOD Wood floors

Size	Grit Available		Part Nos.	Pack
	New Grit	Old Grit		
8" x 50 yards	12	4-1/2	85307	1
	16	4	85300	1
	20	3-1/2	85301	1
	36	2	85302	1
	40	1-1/2	85303	1
	60	1/2	85304	1
	80	0	85305	1
	100	2/0	85306	1

There are 2 grit grading systems for abrasive floor paper. Both systems appear in the table below.



Saitscreen™ Discs

- Cloth screen impregnated with silicon carbide grain
- **Long life**
- Non-loading
- Double sided for long life
- **Excellent for removing paint and varnish from floors**

WOOD Wood

CONCRETE Ceramic tile, cement

Size	Grit	Part No.	Qty Per Box
16"	60	88606	10
	80	88608	10
	100	88610	10
	120	88612	10
17"	60	88706	10
	80	88708	10
	100	88710	10
	120	88712	10
18"	80	88808	10
	100	88810	10
	120	88812	10
20"	60	88006	10
	80	88008	10
	100	88010	10
	120	88012	10

COATED ABRASIVES



- For orbital sanding machines

Saitscreen™

- Silicon carbide grain
- Long life
- Non-loading
- Double sided
- **Excellent for removing paint and varnish**

WOOD Wood

CONCRETE Concrete

Size	Grit	Part No.	Qty Per Box
Saitscreen™ 12 x 24	80	88002	10
	100	88003	10
	120	88004	10

FLOOR SANDING



Floor Sanding Rolls

- Professional quality for use in tough industrial jobs
- Box label UPC bar coded for easy identification and inventory maintenance

Saitscreen™

- Non-gouging for safe use on all floor surfaces
- Popular with DIY homeowners for ease of use

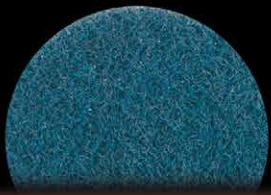

NON-WOVEN

- Non-woven abrasives for use in a variety of applications especially in the metal working industry.
- Constructed of nylon fibers with a resin binder to hold the nylon and grains together.
- Changes the surface of the material without removing or damaging the base materials.
- Reduce the risk of under-cutting or gouging the workpiece.



Sand-Light™ Abrasive Hand Pads (pg. 119):

- 6 x 9 hand pads for hand use



SAIT-LOK™ and SAIT-LOK-R™ (pg. 121):

- Surface conditioning discs 1-1/2", 2", 3", 4" discs for mechanical use

Surface Conditioning, Sand-Light™ & Buffing Discs (pg. 122, 123 & 130):

- Surface Conditioning Discs available 4", 4-1/2", 5", 6", 7", 8" hook and loop discs for excellent removal of surface coatings and contaminants
- Sand-Light™ Blending Discs for mirror finishing and blending
- Buffing Discs designed for cosmetic finishing



Surface Conditioning Belts (pg. 120):

- High speed removal of surface coatings and contaminants
- Available in coarse, medium and very fine



SAIT-Strip™ (pg. 129):

- High speed stripping tool used for removing paint, rust or other contaminants from surfaces



Flap Brushes (pg. 124):

- Provide a linear finish on a variety of materials



Interleaf & Flap Wheels (pg. 125):

- Constructed with alternating flaps of surface conditioning material and coated abrasive material for a high cut rate and a uniform scratch pattern



Unitized Wheels and Type 27 (pg. 127):

- Constructed by bonding and compressing layers of non-woven materials
- Excellent for light deburring to fine finishing



Sand-Light™ Flap Discs (pg. 126):

- For general surface preparation and finishing
- Layered flaps provide long life
- Ideal for cleaning, grinding, deburring, blending, finishing, and polishing



NEW! SAIT Grind & Finish (pg. 126):

- Combines coated and non-woven abrasives which allows you to "Grind & Finish" with one product reducing time and labor



Convolute Wheels (pg. 128):

- Dense, non-woven wheels for use in aggressive deburring, weld blending and polishing



Brown

- Heavy duty
- Excellent for removing heavy rust and cleaning welds

METAL Ferrous and/or non-ferrous metals

Maroon

- General purpose
- For removing light rust
- Excellent for cleaning and brightening

METAL Ferrous and/or non-ferrous metals

Black

- For blending and finishing
- Excellent for paint removal

STAINLESS Stainless steel

METAL Ferrous and/or non-ferrous metals

Green

- General cleaning
- Excellent for stripping paint and varnish

METAL Ferrous and/or non-ferrous metals

WOOD Paint, varnish

Gray

- Ultra fine
- For light finishing
- Excellent for sanding before/between finish coats

METAL Non-ferrous metals

WOOD Wood

White

- Light duty
- For light cleaning and polishing

WOOD Fiberglass, vinyl, plastic

CONCRETE Ceramic



Size	Grade	Color	Part Nos.	Pads Per Box
6 x 9	Heavy Duty	Brown	77440	20
	General Purpose	Maroon	77447	20
	Stainless	Black	77446	20
	Stripper	Green	77496	20
	Ultra Fine	Gray	77448	20
	Light Duty	White	77486	20

Handle available for uniform finishing on page 145



- Non-woven synthetic fiber impregnated with abrasive grain for surface conditioning without damage to or removal of base material. Resists loading and heat build-up
- Wet/dry construction for use in a wide range of applications
- Available in a variety of grades from heavy duty to polishing applications
- Reusable and long lasting design for economical use
- Box label UPC bar coded for easy identification and inventory maintenance

NON-WOVEN
ABRASIVES

NON-WOVEN

Belts



Benchstand



File Sander



Portable Sander



Backstand

NON-WOVEN

Brown

- Coarse
- Excellent for deburring, blending
- For use on mill marks, tool marks, to create a smooth transition on surface profiles

STAINLESS Stainless steel

METAL Ferrous and/or non-ferrous materials

WOOD Fiberglass and rubber

Maroon

- General purpose
- Excellent for blending and cleaning
- Reduce uneven edges on adjoining surfaces
- Remove coatings, gaskets, and surface discolorations

STAINLESS Stainless steel

METAL Ferrous and/or non-ferrous materials

WOOD Fiberglass and rubber

Blue

- Very fine
- Excellent for cleaning and finishing
- Reduce surface roughness
- Polish welds
- Use to apply cosmetic grain or scratch patterns

STAINLESS Stainless steel

METAL Ferrous and/or non-ferrous materials

WOOD Fiberglass and rubber



Size	Coarse Brown	Medium Maroon	Very fine Blue	Qty Per Box
1/2 x 18	77510	77511	77512	10
1/2 x 24	77515	77516	77517	10
3/4 x 18	77520	77521	77522	10
3/4 x 20-1/2	77575	77576	77577	10
3-1/2 x 15-1/2	77500	77501	77502	10
1 x 42	-	77526	-	10
2 x 48	77530	77531	-	10
2 x 60	77535	-	-	10
3 x 21	77570	77571	77572	10
3 x 24	77560	77561	77562	10
4 x 24	77565	77566	-	10
6 x 48	77540	77541	-	5

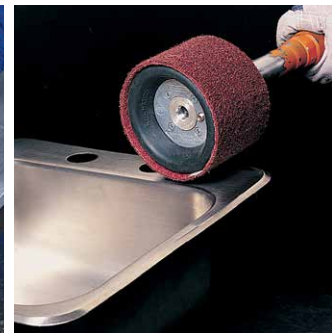

Tech INFO

- Non-woven synthetic fiber impregnated with abrasive grain for surface conditioning without damage to or removal of base material. Resists loading and heat build-up
- Offered in very narrow widths for use on tight radii and hard to reach applications
- Flexible yet extra durable splice method for resistance to breaking or cracking under severe stress

NON-WOVEN ABRASIVES

NON-WOVEN

NON-WOVEN Deburring & Cleaning

Discs



Portable Grinder

Brown

- Heavy duty
- Excellent for heavy deburring, removing weld spatter and blending tool / mill marks, rust removal

STAINLESS Stainless steel

METAL Ferrous and/or non-ferrous materials

WOOD Fiberglass, gaskets

Maroon

- General purpose
- Excellent for light deburring, blending scratch patterns, removing coatings/adhesives

STAINLESS Stainless steel

METAL Ferrous and/or non-ferrous materials

WOOD Fiberglass, gaskets

Blue

- Very fine
- Excellent for cosmetic grain finishing, polishing welds, and reducing grinding marks

STAINLESS Stainless steel

METAL Ferrous and/or non-ferrous materials

WOOD Fiberglass, gaskets



SAIT-LOK™

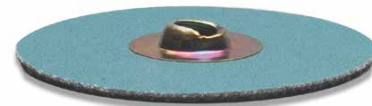

All-metal attachment on disc ensures a secure fit to the backing pad

SAIT-LOK-R™



Nylon screw threaded hub for easy mounting to the backing pad



See page 145 for backing pads

Hook & Loop style discs in 4" - 8" available on page 122

See page 130 for Buffing Discs

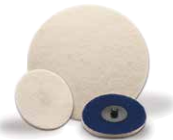

Size	Grade	Color	SAIT-LOK™ Part No.	SAIT-LOK-R™ Part No.	Qty Per Box
1-1/2"	Coarse	Brown	77200	77300	50
	Medium	Maroon	77202	77302	50
	Very Fine	Blue	77203	77303	50
2"	Coarse	Brown	77206	77306	50
	Medium	Maroon	77208	77308	50
	Very Fine	Blue	77209	77309	50
3"	Coarse	Brown	77212	77312	25
	Medium	Maroon	77214	77314	25
	Very Fine	Blue	77215	77315	25
4"	Coarse	Brown	-	77318	25
	Medium	Maroon	-	77320	25
	Very Fine	Blue	-	77321	25

NON-WOVEN
ABRASIVES

NON-WOVEN

**Tech
INFO**

- For finer finishing prior to buffing, use Sand-Light™ blending discs on page 125
- Non-woven synthetic fiber coated with aluminum oxide grain resists loading for long life
- Flexible construction for use on contoured surfaces
- Non-woven disc can be switched to laminated disc using same backing pads for less downtime
- Box label UPC bar coded for easy identification and inventory maintenance

Discs

NON-WOVEN HOOK & LOOP

Deburring & Cleaning



Disc Sander Angle Grinder Portable Grinder



See page 130 for Buffing Discs

Brown

- Heavy duty
- Excellent for heavy deburring, removing weld spatter and blending tool / mill marks, rust removal

STAINLESS Stainless steel, high tensile steel

METAL Ferrous and/or non-ferrous materials

WOOD Fiberglass

Maroon

- General purpose
- Excellent for light deburring, blending scratch patterns, removing coatings/adhesives

STAINLESS Stainless steel, high tensile steel

METAL Ferrous and/or non-ferrous materials

WOOD Fiberglass

Blue

- Very fine
- Excellent for cosmetic grain finishing, polishing welds, and reducing grinding marks

STAINLESS Stainless steel, high tensile steel

METAL Ferrous and/or non-ferrous materials

WOOD Fiberglass

A variety of 1/4" shank, 5/16-24 and 5/8-11 backing pads are available for use on drills, dual action/random orbital sanders, and right angle grinders/sanders. See page 145

SAIT-LOK™ & SAIT-LOK-R™ discs available in 1-1/2" - 3" on page 121

Size	Grade	Color	Part No.	Qty Per Box
4"	Coarse	Brown	77116	10
	Medium	Maroon	77117	10
	Very Fine	Blue	77115	10
4-1/2"	Coarse	Brown	77118	10
	Medium	Maroon	77120	10
	Very Fine	Blue	77122	10
5"	Coarse	Brown	77124	10
	Medium	Maroon	77126	10
	Very Fine	Blue	77128	10
6"	Coarse	Brown	77130	10
	Medium	Maroon	77132	10
	Very Fine	Blue	77134	10
7"	Coarse	Brown	77136	10
	Medium	Maroon	77138	10
	Very Fine	Blue	77140	10
8"	Coarse	Brown	77142	10
	Very Fine	Blue	77146	10

Tech INFO

- Hook and loop fastening system allows for quick changes and less downtime
- Non-woven synthetic fiber impregnated with abrasive grain for surface conditioning without damage to or removal of base material. Resists loading and heat build-up
- Used in a wide variety of applications including cleaning, polishing, blending, and deburring
- Resilient shape and performance characteristics for contour and radius applications
- Box label UPC bar coded for easy identification and inventory maintenance

NON-WOVEN ABRASIVES

NON-WOVEN

NON-WOVEN

Light Blending & Final Finishing

Sand-Light™ Discs



Disc Sander



Portable Grinder



Bench Grinder

Sand-Light™ Blending Discs

- For minor finishing and blending applications
- Less aggressive cutting than traditional surface conditioning discs
- Great for final finishing prior to buffing with compounds

ALUMINUM Aluminum

STAINLESS Stainless steel

METAL Ferrous and non-ferrous materials

Available in SAIT-LOK™, Hook and Loop, and arbor hole discs

Packaging

SAIT-LOK™	2"	50/box
	3"	25/box
Hook and Loop		10/box
Arbor Hole		10/box

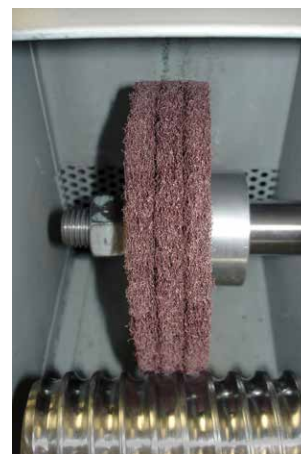

Size	Grade	Arbor Hole Part No.	Qty Per Box
6 x 1/2	Medium	77162	10
	Very Fine	77165	10
8 x 1/2	Medium	77182	10
	Very Fine	77185	10

Medium

- General purpose
- Excellent for blending surface imperfections, coated abrasive burrs

ALUMINUM Aluminum

STAINLESS Stainless steel

METAL Ferrous and non-ferrous materials



Very Fine

- Excellent for blending surface imperfections, final finishing, and preparation prior to coating

ALUMINUM Aluminum

STAINLESS Stainless steel

METAL Ferrous and non-ferrous materials

See page 145 for backing pads

Size	Grade	SAIT-LOK™ Part No.	Qty Per Box
2" Thick	Medium	77672	50
	Very Fine	77675	50
3" Thick	Medium	77682	25
	Very Fine	77685	25

Size	Grade	Hook & Loop Part No.	Qty Per Box
5" Thick	Medium	77382	10
	Very Fine	77385	10
6" Thick	Medium	77392	10
	Very Fine	77395	10



- Use the Medium grade for light finishing after using surface conditioning discs
- Use the Very Fine grade followed by the SAIT Buffing Discs and compounds for a near mirror finish
- Use the slowest speed possible for optimum results

NON-WOVEN
ABRASIVES

NON-WOVEN

Flap Brushes

NON-WOVEN



Pedestal Grinder

Flap Brushes

- Capable of conforming to concave, flat, and irregular surfaces
- Creates matte and satin finishes without lines on work piece
- Excellent for blending, cleaning welds, and removing corrosion, rust, or scaling
- **Excellent for grain, antique, and satin finishes, finishing aluminum extrusions, and applying an inline brushed finish on aluminum and stainless steel**

ALUMINUM Aluminum, brass

STAINLESS Stainless steel



Size	Grade	Max RPM	Part No.	Qty Per Box
6 x 1 x 2	Medium	3,400	77325	3
	Very Fine	3,400	77327	3
8 x 1 x 3	Medium	3,200	77330	3
	Very Fine	3,200	77332	3

See page 148 for mounting flanges and reducing bushings

Tech INFO

- Flexible, consistent face for ease of use
- Cool, smooth running for less operator fatigue
- Non-woven synthetic fiber impregnated with abrasive grain for surface conditioning without damage to or removal of base material. Resists loading and heat build-up



Die Grinder

Flap Wheels

- Capable of conforming to concave, flat, and irregular surfaces
- Creates matte and satin finishes without lines on work piece
- Excellent for blending, cleaning welds, and removing corrosion, rust, or scaling
- **Excellent for grain, antique, and satin finishes, finishing aluminum extrusions, and applying an inline brushed finish on aluminum and stainless steel**

ALUMINUM Aluminum, brass

STAINLESS Stainless steel



Size	Grade	Max RPM	Part No.	Qty Per Box
1 x 1 x 1/4	Coarse	20,000	77780	10
	Medium	20,000	77781	10
	Fine	20,000	77782	10
2 x 1 x 1/4	Coarse	15,000	77785	10
	Medium	15,000	77786	10
	Fine	15,000	77787	10
3 x 1 x 1/4	Coarse	8,600	77790	10
	Medium	8,600	77791	10
	Fine	8,600	77792	10
3 x 2 x 1/4	Coarse	8,600	77805	5
	Medium	8,600	77806	5
	Fine	8,600	77807	5

Interleaf Wheels

Medium Grade

- Medium surface conditioning material with either 60 or 80 grit coated abrasive material
- **Excellent for removing heavy oxidation, blending, cleaning, and deburring**

ALUMINUM Aluminum

STAINLESS Stainless steel

METAL Ferrous and non-ferrous materials

WOOD Fiberglass



Very Fine Grade

- Very fine surface conditioning material with either 120 or 180 grit coated abrasive material
- **Excellent for grain finishing, satin finishing, and linear scratch patterns**

ALUMINUM Aluminum

STAINLESS Stainless steel

METAL Ferrous and non-ferrous materials

WOOD Fiberglass

Size	Grit	Grade	Max RPM	Part No.	Qty Per Box
1 x 1 x 1/4	60	Medium	20,000	77700	10
	80	Medium	20,000	77702	10
	120	Very Fine	20,000	77704	10
	180	Very Fine	20,000	77706	10
2 x 1 x 1/4	60	Medium	15,000	77710	10
	80	Medium	15,000	77712	10
	120	Very Fine	15,000	77714	10
	180	Very Fine	15,000	77716	10
3 x 1 x 1/4	60	Medium	8,600	77730	10
	80	Medium	8,600	77732	10
	120	Very Fine	8,600	77734	10
	180	Very Fine	8,600	77736	10
3 x 2 x 1/4	60	Medium	8,600	77750	5
	80	Medium	8,600	77752	5
	120	Very Fine	8,600	77754	5
	180	Very Fine	8,600	77756	5



- Interleaf flap wheels are constructed with alternating flaps of surface conditioning material and coated abrasive material for a high cut rate and a uniform scratch pattern. Provides blending action while leaving final finish on work piece
- Smear-resistant non-woven material for clean, smear-proof work surfaces
- Interleaf design makes product more aggressive than SAIT non-woven flap brushes and less aggressive than SAIT coated abrasive flap wheels

Flap Discs



Angle Grinder

NON-WOVEN



SAIT GF GRIND & FINISH



- Combines coated and non-woven abrasives which allows you to "Grind & Finish" with one product reducing time and labor
- Cushioned grinding effect allows for effortless blending and finishing of contoured work pieces
- Aluminum oxide specifications available in coarse, medium, and very fine
- Ceramic specification (High Performance) available in 40 grit and 60 grit - provides exceptionally long life

- METAL** Ferrous and/or non-ferrous metals
- STAINLESS** Stainless steel, high tensile steel, titanium

State-of-the-art abrasive cloth for the quick, cool & controlled removal of material

Surface conditioning flaps ensure an even finish at low pressure

— Applications —

- Ideal for cleaning of weld spatter and light deburring operations
- Operate at lower speeds for optimum performance:
Optimal RPMs
4-1/2": 4,000 RPM | 5": 3,500 RPM

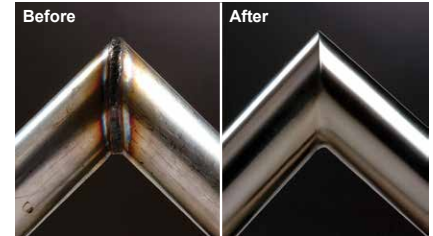

Allows you to grind down weld seams and provide a flawless finish in one single operation

Size	Grade	Grit	Coated Abrasive Mat'l	Part No.	Qty Per Box
4-1/2" x 7/8"	Coarse	60	A/O	77720	10
	Medium	80	A/O	77721	10
	Very Fine	150	A/O	77723	10
5" x 7/8"	Coarse	40	Ceramic	77760	10
	Coarse	60	Ceramic	77761	10
	Coarse	60	A/O	77725	10
	Medium	80	A/O	77726	10
	Very Fine	150	A/O	77728	10
	Coarse	40	Ceramic	77766	10
	Coarse	60	Ceramic	77767	10

- Max RPM's**
4-1/2" 13,300
5" 12,200
- Optimal RPM's**
4-1/2" 4,000
5" 3,500



- 10pcs / canister (box)
- Product and features prominently displayed on canister

NON-WOVEN ABRASIVES

NON-WOVEN



Sand-Light™ Flap Discs

- Non-woven material – layered flaps create a thick, cushioned design which provides a nice finish
- Designed for surface preparation, cleaning, and finishing applications

- METAL** Ferrous metals
- STAINLESS** Stainless steel, high tensile steel
- ALUMINUM** Non-ferrous metals

Size	Grade	Color	Part No.	Qty Per Box
4-1/2" x 7/8"	Coarse	Brown	71980	5
	Medium	Maroon	71982	5
	Very Fine	Blue	71984	5
5" x 7/8"	Coarse	Brown	71990	5
	Medium	Maroon	71992	5
	Very Fine	Blue	71994	5

RPM's
4-1/2" 13,300
5" 12,200



Angle Grinder



Die Grinder

Unitized Wheels

Series 524 - Soft Density, Medium Grade, Silicon Carbide Grain

- General purpose cleaning, finishing and polishing

Series 532 - Soft Density, Fine Grade, Silicon Carbide Grain

- Requires light pressure for fine finishing and polishing
- Highly conformable material
- Provides clean, bright surface on stainless steel
- Finer finish than the 524 series

Series 632 - Medium Density, Fine Grade, Silicon Carbide Grain

- Requires light pressure for fine finishing and polishing
- Highly conformable material
- Provides clean bright stainless steel finishes, blends tool marks, and removes slight surface imperfections

Series 731 - Medium Density, Fine Grade, Aluminum Oxide Grain

- Light pressure for blending and finishing
- High edge durability
- High degree of stock removal, while maintaining bright finish
- Smaller contact area than the 632 series

Series 811 - Hard Density, Coarse Grade, Aluminum Oxide Grain

- Highest stock removal and edge breaking capability
- Most aggressive for deburring

Series 821 - Hard Density, Medium Grade, Aluminum Oxide Grain

- Provides high stock removal, long life and productivity
- Very durable on edge

STAINLESS Stainless steel, high tensile steel

ALUMINUM Aluminum

METAL Ferrous and/or non-ferrous metals

Unitized Type 27 Wheels

Go from a coarse grind finish to a near mirror finish with the Unitized Wheel



Size	Series	Grain	Density	Grade	Max RPM	Part No.	Qty Per Box
4-1/2" x 7/8"	524	S/C	Soft	Medium	10,000	77875	4
	732	S/C	Medium	Fine	10,000	77880	4
	811	A/O	Hard	Coarse	10,000	77885	4
	821	A/O	Hard	Medium	10,000	77890	4

Unitized Wheels

Size	Series	Grain	Density	Grade	Max RPM	Part No.	Qty Per Box	Mandrel Part No.
1 x 1 x 3/16	821	A/O	Hard	Medium	30,000	77830	10	95240
3 x 1/2 x 1/4	821	A/O	Hard	Medium	18,000	77835	10	95002
3 x 1/4 x 1/4	524	S/C	Soft	Medium	18,000	77840	10	95002
3 x 1/4 x 1/4	532	S/C	Soft	Fine	18,000	77845	10	95002
3 x 1/4 x 1/4	632	S/C	Medium	Fine	18,000	77850	10	95002
3 x 1/4 x 1/4	731	A/O	Medium	Fine	18,000	77855	10	95002
3 x 1/4 x 1/4	811	A/O	Hard	Coarse	18,000	77860	10	95002
3 x 1/4 x 1/4	821	A/O	Hard	Medium	18,000	77865	10	95002



- Constructed by bonding and compressing layers of non-woven material
- Hot pressed to form a solid block from which wheels are cut



Bench Grinder

Deburring 8SF-Medium Density

- Excellent starting point for general purpose deburring, blending, and weld polishing
- Silicon carbide grain for fast cut rate and finest finish
- Comparable to competitive 8SF products

METAL Ferrous and non-ferrous materials

ALUMINUM Aluminum

STAINLESS Stainless steel, high tensile materials

Deburring 9SF-Hard Density

- Excellent for aggressive deburring, blending
- Silicon carbide grain for fast cut rate and finest finish
- Comparable to competitive 9SF products

METAL Ferrous and non-ferrous materials

ALUMINUM Aluminum

STAINLESS Stainless steel, high tensile materials



NOTE: Wheels must be run in the direction of the arrow as indicated on the wheel.

Size	Spec.	Density	Grain	Grade	Max RPM	Part No.	Qty Per Box
6 x 1/2 x 1	9SF	Hard	Silicon Carbide	Fine	6,000	77810	4
6 x 1 x 1	8SF	Medium	Silicon Carbide	Fine	6,000	77815	3
6 x 1 x 1	9SF	Hard	Silicon Carbide	Fine	6,000	77820	3
8 x 1 x 3	9SF	Hard	Silicon Carbide	Fine	4,500	77825	3



See page 148 for mounting flanges and reducing bushings



Tech
INFO

- Convolute wheels are constructed by wrapping non-woven nylon, impregnated with abrasive grains, around a hard core to form a homogenous wheel
- Dense, non-woven construction for long lasting wear and high edge durability
- Smooth running for less operator fatigue
- Non-metallic for no workpiece contamination
- Smear-resistant formulation to greatly reduce the possibility of smearing
- Provides best durability, stock removal, and finest finish for increased productivity

NON-WOVEN
ABRASIVES

NON-WOVEN

NON-WOVEN

Sait-Strip™



Angle Grinder Die Grinder Pedestal Grinder Portable Grinder

SAIT-Strip™

- Fast, safe removal of surface contaminants
- Available in SAIT-LOK™, SAIT-LOK-R™, Type 27, and spindle mounted wheels
- Excellent for cleaning welds, removing corrosion, rust, scaling, and blending
- Great for removing paints, varnishes and sealants from difficult to reach surfaces

METAL Ferrous and/or non-ferrous metals

STAINLESS Stainless steel, high tensile steel



SAIT-Strip™ Type 27

Size			Max RPM	Part Number	Qty Per Box
Dia.	Width	Bore			
4-1/2	1/2	7/8	10,000	77230	4

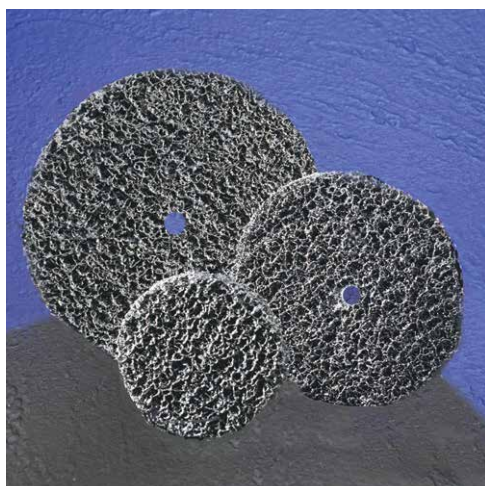

SAIT-Strip™ Arbor Hole Discs

- Fast, safe removal of surface contaminants

METAL Ferrous and/or non-ferrous metals

STAINLESS Stainless steel, high tensile steel

Size			Max RPM	Part Number	Qty Per Box
Dia.	Width	Bore			
4	1/2	1/4	6,000	77270	10
6	1/2	1/2	4,000	77275	5
8	1/2	1/2	3,000	77280	5



SAIT-Strip™ Discs

Size	Max RPM	SAIT-LOK™ Part No.	SAIT-LOK-R™ Part No.	Qty Per Box
2"	12,000	77250	77350	25
3"	8,500	77255	77355	10

Tech INFO

- Constructed of large nylon filament, providing an open, non-loading surface
- Utilizes coarse silicon carbide grain for rapid removal of surface contaminants, while producing fine finishes

NON-WOVEN
ABRASIVES

NON-WOVEN

Buffing Discs

NON-WOVEN



Disc Sander Angle Grinder Portable Grinder

Buffing Discs

- Premium quality buffing material
- Designed for final cosmetic finishing
- Available in hook and loop and SAIT-LOK-R™

STAINLESS Stainless steel and other high tensile alloys

ALUMINUM Aluminum, brass and other non-ferrous metals



Size	SAIT-LOK-R™ Part No.	Hook & Loop Part No.	Qty Per Box
2"	41012	-	50
3"	41013	-	25
5"	-	41055	10
7"	-	41057	10

See page 145 and 148 for backing pads

Compound Kit

The compound kit contains the following:

Brown Bar: Used for buffing aluminum, brass, copper, wood, plastics, hard rubber, and painted surfaces. Also called tripoli rouge.

White Bar: Used for buffing stainless steel, carbon steel, nickel, aluminum, and chromium to a high luster shine.

Red Bar: For buffing precious metals like gold, silver, platinum, sterling, and other high-end metals. Can also be used to further enhance materials that have already been buffed with other compounds. The finest grade.

Black Bar: Used to buff contaminants out prior to finishing. Will remove rust, stains, scale, and other contaminants. An extremely fast cutting material. Also called emery cake.

Individual bars are also available.



Description	Part No.	Qty Per Box
Buffing Compound Kit	41000	1
Brown Bar	41024	1
White Bar	41022	1
Red Bar	41020	1
Black Bar	41026	1

Tech
INFO

- To achieve the best finish possible, use with the soft backing pads (part numbers 95255 & 95257) and the compound kit (part number 41000)
- In general, a slower speed achieves a better finish and reduces heat
- For use on right angle grinder, D/A (dual action) sanders, and right angle air grinders

WIRE BRUSHES



United Abrasives' brushes consist of only the highest grade industrial tempered wire and state-of-the-art construction, designed for off-hand equipment. The various styles cover a multitude of applications.



Features and Benefits

Brushes are available in a variety of wire types. The proper brush for the application should be selected based on the characteristics of the brush, including wire type. All BlueLine™ packaging is one piece per package.

Knot wire brushes provide high impact action and offer low to medium flexibility through the use of twisted wire tufts for heavy duty applications, such as weld cleaning. Knot wire brushes are available in 2 knot configurations.



Flag at end of wire tuft provides additional brush flexibility for irregular surface preparation.



Extremely narrow tufted face is ideal for bead weld preparation.

Crimped wire brushes are general purpose brushes that provide higher flexibility and cleaning action through the use of flexible wire points. They offer a wider work face than knot style and are ideal for light applications such as rust or paint removal.



Flexible wire points provide cleaning action for light applications.

Wire Size Specifications

The thickness of brush wire will impact the end result of the workpiece. Fine wire such as .008 will produce a finer finish and will yield a longer brush life. Thicker wires, such as .014 and .020 or higher, will be more aggressive and will decrease production times.

Brush Fill Materials

Carbon steel, the most durable, high strength fill material available for general purpose cleaning applications, is suitable for light to heavy duty cleaning depending on the wire diameter.

Stainless Steel fill material is suitable on metals such as aluminum and stainless steel when corrosion resistance and non-contaminant brushing actions are desired.

WIRE
BRUSHES

BRUSHES



WIRE BRUSHES

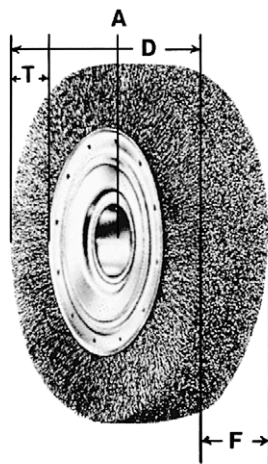

Common Brush Terminology

- A = Arbor Hole
- D = Brush Diameter
- F = Face Width
- T = Trim Length

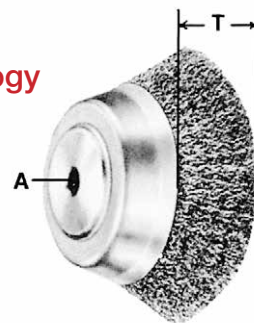

Application Information

- Always check warning labels for safety information
- Always follow safety guidelines included with each brush package
- Proper application of wire brushes is for the removal of various surface contaminants, not the removal of the base stock material
- The power tool determines the size and speed of the brush to be used
- Check the R.P.M. rating of the tool to verify that it does not exceed the Maximum Safe Free Speed (M.S.F.S.) of the brush
- The slowest speed that will do the job is the most efficient use of the brush. Running at the M.S.F.S. is not necessarily the most efficient speed
- The tool shaft must match the arbor hole of the brush
- The tips of wire at the end of the brush do the work. Excessive pressure will cause premature wire breakage, reduced brush life, increased heat build-up and rapid dulling

Power Brush Safety Requirements

1. **Safety Goggles:** Safety goggles, or full face shields worn over safety glasses with side shields, **MUST BE WORN** by all OPERATORS and OTHERS IN THE AREA OF POWER BRUSH OPERATIONS. Comply with the requirements of ANSI Z87.1 ("Occupational Eye and Face Protection").
2. **Guards:** Keep all machine guards in place.
3. **Speeds:** Observe all speed restrictions indicated on the brushes, containers, labels, or printed in pertinent literature. "MSFS" or "MAX.SFS" means Maximum Safe Free Speed (R.P.M.) - spinning free with no work applied. For reasons of safety, the "MSFS/MAX.SFS" should not be exceeded under any circumstances.
4. **Safety Standard:** Comply with the safety standards of the American National Standards Institute, ANSI B165.1 and ANSI B165.2 - "Safety Requirements - Power Brushes."
5. **Protective Equipment:** Appropriate protective clothing and equipment (such as full face shield, gloves, respirator, etc.) must be used where a possibility of injury exists that can be prevented by such equipment.
6. **Before starting brush:** Use eye protection and safety equipment. Inspect brush for rust, damage, speed limit, etc. If no-load speed marked on the power tool is higher than the brush speed limit, do not mount brush. Inspect and jog machine to assure the brush is mounted properly and securely, machine guards are in place, no vibration, etc. Run machine at operating speed for at least one minute before applying work. **DO NOT STAND IN FRONT OF OR IN LINE WITH BRUSH.**

All United Abrasives brushes comply with the standards of the American Brush Manufacturers' Association, the American National Standards Institute, and the Canadian Standard Association Safety Code.

www.UnitedAbrasives.com

BRUSHES

Bench/Large Cup



Bench Grinder



Angle Grinder

Bench Wire Wheels

- Dense, compact crimped steel wire brush face
- **May be stacked to achieve wider work face**
- Primary application: For general scale removal, cleaning and surface preparation
- Standard 2" arbor, with adaptor to listed arbor
- Includes bushing pairs to adapt to variety of arbors

Additional arbors available

Part No.	Size
95201	2 x 1/2
95203	2 x 5/8
95204	2 x 3/4
95206	2 x 1
95207	2 x 1-1/4

**** not available for part number 09558 and 09555



Dia.	Size		Face Width	Trim Length	Max RPM	INDUSTRIAL		BLUE LINE™ Part No.
	Wire	Arbor				Part No.	Std Pkg	
6	.014	5/8, 1/2	Wide	1-1/16"	6,000	09557	1	06557
6	.014	5/8, 1/2	Narrow	1-3/16"	6,000	09558****	1	06558
6	.008	5/8, 1/2	Narrow	1-1/16"	6,000	09555****	1	06555
7	.014	5/8	Wide	1-9/16"	6,000	09559	1	06559
8	.014	5/8	Wide	1-1/2"	4,000	01411	1	06556
10	.014	3/4	Wide	2"	3,600	09560	1	-

Note: Wide 1"
Narrow 1/2"

Packaging

Standard industrial packaging or Blue Line™ point of sale display packaging

Large Cup Brushes

- Available in the following wire types:
 - Knot wire for low to medium flexibility and aggressive cutting action
 - Crimped wire which has higher flexibility for light cleaning and removal, especially on irregular surfaces
- Primary application: **For fast cleaning of large surfaces**

Knot Wire - nut inside

Dia.	Size		Rows	Trim Length	Max RPM	INDUSTRIAL		BLUE LINE™ Part No.
	Wire	Arbor				Part No.	Std Pkg	
4	.020	5/8-11	1	1-3/8"	9,000	03407**	1	06407
4	.020	5/8-11	1	Stainless*	9,000	03406***	1	06406
6	.020	5/8-11	1	1-3/4"	6,600	03409***	1	06409
6	.035	5/8-11	1	1-3/4"	6,600	03410***	1	06410
6	.020	5/8-11	2	1-3/4"	6,000	03411***	1	06411
6	.035	5/8-11	2	1-3/4"	6,000	03412***	1	06412
6	.020	5/8-11	1	Stainless*	6,600	03413***	1	-

Crimped Wire - nut inside

4	.020	5/8-11	-	1-1/8"	9,000	09551	1	06551
5	.020	5/8-11	-	1-1/2"	8,000	09552	1	-
5	.020	5/8-11	Stainless*	1-1/2"	8,000	09554	1	06554
6	.020	5/8-11	-	1-1/2"	6,600	09553	1	06553



Packaging

Standard industrial packaging or Blue Line™ point of sale display packaging

* 302 stainless steel wire used

** nut on outside

***nut on outside in Canada only

WIRE BRUSHES

BRUSHES

Small Cup



Angle Grinder

BRUSHES

Small Cup Brushes

- For use on small grinders
- Available in the following wire types:
 - Knot wire for low to medium flexibility and aggressive cutting action
 - Crimped carbon steel wire for light cleaning and where greater flexibility is required
 - Stainless steel knot wire for use on stainless, aluminum, and high strength alloys
- Variety of threaded arbors available

Packaging

Standard industrial packaging or Blue Line™ point of sale display packaging

*302 stainless steel wire used



Size			Wire Style	Matl Type	Max RPM	INDUSTRIAL		BLUE LINE™
Dia.	Wire	Arbor				Part No.	Std Pkg	Part No.
2-3/4	.014	5/8-11	Knot	Carbon	14,000	03414	6	06414
2-3/4	.014	M14 x 2.0	Knot	Carbon	14,000	03415	6	06415
2-3/4	.014	M10 x 1.25	Knot	Carbon	14,000	03416	6	06416
2-3/4	.014	M10 x 1.5	Knot	Carbon	14,000	03417	6	06417
2-3/4	.014	1/2-13	Knot	Carbon	14,000	03418	6	06418
2-3/4	.020	5/8-11	Knot	Carbon	14,000	03501	6	06501
2-3/4	.020	M14 x 2.0	Knot	Carbon	14,000	03502	6	-
2-3/4	.020	M10 x 1.25	Knot	Carbon	14,000	03503	6	06503
2-3/4	.020	M10 x 1.5	Knot	Carbon	14,000	03504	6	06504
2-3/4	.020	1/2-13	Knot	Carbon	14,000	03505	6	06505
2-3/4	.014	5/8-11	Knot	Stainless*	14,000	03419	6	06419
2-3/4	.014	M14 x 2.0	Knot	Stainless*	14,000	03423	6	-
2-3/4	.014	M10 x 1.25	Knot	Stainless*	14,000	03422	6	-
2-3/4	.014	1/2-13	Knot	Stainless*	14,000	03420	6	-
2-3/4	.020	5/8-11	Knot	Stainless*	14,000	03506	6	06506
2-3/4	.020	M14 x 2.0	Knot	Stainless*	14,000	03507	6	-
2-3/4	.020	M10 x 1.25	Knot	Stainless*	14,000	03508	6	-
2-3/4	.020	1/2-13	Knot	Stainless*	14,000	03510	6	-
2-3/4	.014	5/8-11	Crimped	Carbon	14,000	01401	6	06401
2-3/4	.014	M14 x 2.0	Crimped	Carbon	14,000	01405	6	06405
2-3/4	.014	M10 x 1.25	Crimped	Carbon	14,000	01404	6	06404
2-3/4	.014	M10 x 1.5	Crimped	Carbon	14,000	01403	6	06403
2-3/4	.014	1/2-13	Crimped	Carbon	14,000	01402	6	06402
2-3/4	.014	5/8-11	Crimped	Stainless*	14,000	01408	6	06408
3-1/2	.020	5/8-11	Knot	Carbon	12,500	03511	1	06511
3-1/2	.020	5/8-11	Knot	Stainless*	12,500	03512	1	06512
3-1/2	.014	5/8-11	Crimped	Carbon	12,500	03513	1	06513
3-1/2	.014	5/8-11	Crimped	Stainless*	12,500	03514	1	06514

WIRE BRUSHES

BRUSHES



Angle Grinder



Knot & Crimped Wire Wheels

- For use on small grinders
- Available in the following wire types:
 - Regular twist covers more surface area in a single pass
 - Stringer bead twist is excellent for welds, flux removal and where a narrow work face is required
 - Crimped carbon steel wire provides flexibility and a wider work face than knot style
 - Stainless steel wire for use on stainless, aluminum, and high strength alloys
- Variety of threaded arbors available

Packaging

Standard industrial packaging or Blue Line™ point of sale display packaging

*302 stainless steel wire used

Regular Twist

Size			Matl Type	Max RPM	INDUSTRIAL		BLUE LINE™
Dia.	Wire	Arbor			Part No.	Std Pkg	Part No.
4	.014	5/8-11	Carbon	20,000	03426	6	06426
4	.014	M14 x 2.0	Carbon	20,000	03427	6	-
4	.014	M10 x 1.25	Carbon	20,000	03428	6	06428
4	.014	M10 x 1.5	Carbon	20,000	03429	6	-
4	.014	1/2-13	Carbon	20,000	03430	6	06430
4	.020	5/8-11	Carbon	20,000	03460	6	06460
4	.014	5/8-11	Stainless*	20,000	03431	6	06431
4	.014	M14 x 2.0	Stainless*	20,000	03435	6	-
4	.014	M10 x 1.25	Stainless*	20,000	03434	6	-
4	.014	M10 x 1.5	Stainless*	20,000	03433	6	-
4	.020	5/8-11	Stainless*	20,000	03461	6	06461
6	.025	5/8-11	Carbon	9,000	03385	3	06385

Stringer Bead / Pipeline

4	.020	5/8-11	Carbon	20,000	03440	6	06440
4	.020	M14 x 2.0	Carbon	20,000	03441	6	06441
4	.020	M10 x 1.25	Carbon	20,000	03442	6	-
4	.020	1/2-13	Carbon	20,000	03444	6	-
4	.020	5/8-11	Stainless*	20,000	03445	6	06445
4	.020	M10 x 1.25	Stainless*	20,000	03447	6	-
4	.020	1/2-13	Stainless*	20,000	03449	6	-
5	.020	5/8-11	SB-Carbon	12,000	03380	6	06380
5	.020	M14 x 2.0	SB-Carbon	12,000	03381	6	-
5	.020	5/8-11	SB-Stainless*	12,000	03382	6	06382
6	.020	5/8-11	SB-Stainless*	12,000	03383	6	06383
6	.020	5/8-11	SB-Carbon	12,000	03384	6	06384
6-1/2	020	5/8-11	SB-Stainless*	9,000	03389	6	06389
6-1/2	020	5/8-11	SB-Carbon	9,000	03391	6	06391

Crimped

4	.014	5/8-11	Carbon	12,500	03450	6	06450
4	.014	M14 x 2.0	Carbon	12,500	03451	6	-
4	.014	M10 x 1.25	Carbon	12,500	03452	6	06452
4	.014	1/2-13	Carbon	12,500	03454	6	06454

Wire Wheels



Angle Grinder

BRUSHES



Packaging

Standard industrial packaging or Blue Line™ point of sale display packaging

*302 stainless steel wire used

Knot Wire Wheels

- Can be used on portable power tools
- Available in the following wire types:
 - Knot wire for low to medium flexibility and aggressive cutting action
 - Stainless steel wire for use on stainless, aluminum, and high strength alloys
- Primary application: **Cleaning, deburring, and scale removal**

Size			Matl Type	Max RPM	INDUSTRIAL		BLUE LINE™
Dia.	Wire	Arbor			Part No.	Std Pkg	Part No.
3	.014	3/8	Carbon	25,000	03377	4	06377
3	.014	1/2, 3/8	Stainless*	25,000	03376	4	06376
4	.014	1/2	Carbon	20,000	03378	4	06378
5	.020	5/8-11	Carbon	12,000	03373	1	06373
5	.020	5/8-11	Stainless*	12,000	03374	1	06374
6	.020	5/8, 1/2	Carbon	9,000	03386	1	06386
6	.020	5/8-11	Carbon	9,000	03388	1	06388
6	.016	5/8, 1/2	Stainless*	9,000	03387	1	06387



Packaging

Standard industrial packaging or Blue Line™ point of sale display packaging

*302 stainless steel wire used

Pipeline Brushes

- **Excellent for use in the pipeline industry**
- Available in the following wire types:
 - Knot wire provides aggressive action in the removal of bead scale, weld flash, or splatter
 - Regular twist and stringer bead twist for higher impact action
 - Stainless steel wire available in stringer bead twist for use on stainless, aluminum, and high strength alloys
- Primary application: **Cleaning, deburring, and scale removal**

Size			Matl Type	Max RPM	INDUSTRIAL		BLUE LINE™
Dia.	Wire	Arbor			Part No.	Std Pkg	Part No.
4	.020	5/8-11	Carbon	20,000	03440	6	06440
4	.020	M14 x 2.0	Carbon	20,000	03441	6	06441
4	.020	M10 x 1.25	Carbon	20,000	03442	6	-
4	.020	1/2-13	Carbon	20,000	03444	6	-
4	.020	5/8-11	Stainless*	20,000	03445	6	06445
4	.020	M10 x 1.25	Stainless*	20,000	03447	6	-
4	.020	1/2-13	Stainless*	20,000	03449	6	-
5	.020	5/8-11	SB-Carbon	12,000	03380	6	06380
5	.020	M14 x 2.0	Carbon	12,000	03381	6	-
5	.020	5/8-11	SB-Stainless*	12,000	03382	6	06382
6	.020	5/8-11	SB-Stainless*	12,000	03383	6	06383
6	.020	5/8-11	SB-Carbon	12,000	03384	6	06384
6	.025	5/8-11	Carbon	9,000	03385	6	06385
6-1/2	.020	5/8-11	SB-Stainless*	9,000	03389	6	06389
6-1/2	.020	5/8-11	SB-Carbon	9,000	03391	6	06391

WIRE BRUSHES

BRUSHES

BRUSHES

Joint/End Brushes



Die Grinder



Street Saw



Joint Brushes

- For use on street saws
- Primary application: **Cleaning concrete expansion joints**

Packaging

1 brush per package

Dia.	Wire Size	Description	Max RPM	Part No.	Std Pkg
12"	.035	Joint Brush 1" Arbor, 7/16 Pinhole	6,000	09570	1

End Brushes

- For use on portable power tools
- **Excellent for use in cleaning and finishing recessed areas or pipes**
- Available in the following wire types:
 - Knot wire provides aggressive cutting action
 - Circular flared end brush excellent for side cleaning action
 - Crimped wire for high flexibility
- 1/4" shank diameter

Packaging

Standard industrial packaging or Blue Line™ point of sale display packaging

*302 stainless steel wire used (Black Shell)



Size Dia.	Wire Wire	Wire Style	Trim Length	Overall Length	Max RPM	INDUSTRIAL		BLUE LINE™
						Part No.	Std Pkg	Part No.
1	.020	Knot Type	1	2-5/8	22,000	02701	12	06701
1	.020	Crimped Wire	1	2-5/8	22,000	02709	12	06709
1	.020	SS-Knot*	1	2-5/8	22,000	02704	12	06704
3/4	.014	Crimped Wire	1	2-5/8	22,000	02702	12	06702
3/4	.014	Knot Type	1-1/8	2-5/8	22,000	02703	12	06703
1-1/2	.012	Circ. Flared Crimped	5/16	1-3/4	20,000	02710	12	06710
2-1/2	.014	Circ. Flared	11/16	1-3/4	20,000	02705	12	06705
2	.014	Crimped Wire Wheel	7/16	1-1/4	25,000	02712	12	06712
3	.014	Circ. Flared Crimped*	7/8	1-3/4	25,000	02711	12	06711
3	.014	Crimped Wire Wheel	15/16	1-1/4	25,000	02713	12	06713
3	.014	Crimped Wire Wheel*	15/16	1-1/4	25,000	02714	12	06714

Scratch/Miscellaneous

BRUSHES



Scratch Brushes

- Excellent for light scale removal
- Available in the following wire types:
 - Carbon steel wire for general purpose cleaning
 - Stainless steel wire is carbon free
 - Brass wire for general purpose cleaning
- Primary application: Maintenance cleaning

*Stainless steel wire used

Size Rows	Wire Size	Type	Part No.	Std Pkg
3 x 19	.014	Curved Handle	05751	12
3 x 19	.014	Curved Handle w/Scraper	05760	12
3 x 19	.012	Curved-Stainless*	05755	12
3 x 14	.014	V-Groove Scratch	05764	12
3 x 14	.012	V-Groove Scratch-Stainless*	05765	12
4 x 16	.014	Shoe Handle	05753	12
4 x 16	.014	Shoe Handle w/Scraper	05761	12
4 x 16	.012	Shoe Handle-Stainless*	05763	12
4 x 19	.014	Curved Handle	05752	12
3 x 7	.006	Small Cleaning Brush-Stainless*	05759	12
3 x 7	.006	Small Cleaning Brush w/Plastic Handle-Stainless*	05766	12
3 x 7	.006	Small Cleaning Brush-Brass	05762	12
3 x 7	.006	Small Cleaning Brush w/Plastic Handle-Brass	05768	12
3 x 15	-	Chipping Hammer Brush	05757	12

Miscellaneous Brushes

Metal Chip Brush

- Durable, long lasting
- For cleaning metal chips from work surfaces

Acid Brushes

- Quality horsehair bristles
- Machine trimmed and crimped to specification

Paint Brushes

- Quality horsehair bristles/Wood handle
- Use for solvents and chemicals

Brush Type	Width	Trim Length	Overall Length	Part No.	Std Pkg
Metal Chip	1-1/4"	1-3/8"	5-5/16"	00510	12 pcs
	3/8"	3/4"	6"	00501	1 gross
Acid Brush	7/16"	7/8"	6-1/2"	00502	1 gross
	9/16"	7/8"	6-1/8"	00503	1 gross
Paint Brush	1/2"	1-1/2"	7"	00511	72 pcs
	1"	1-1/2"	7-1/2"	00512	72 pcs
	1-1/2"	1-1/2"	7-1/2"	00513	72 pcs
	2"	1-1/2"	7-1/2"	00514	72 pcs
Paint Brush	3"	1-1/2"	8"	00515	48 pcs
	4"	2-1/4"	9-1/2"	00516	12 pcs



WIRE BRUSHES

BRUSHES

BRUSHES

Nylon



Hand Brush



Die Grinder



Bench Grinder



Angle Grinder

Nylon Abrasive Brushes

- Available in silicon carbide
- Use on steel, aluminum, copper, brass, stainless steel, super alloys, plastics, composites, ceramics, wood, leather



Large Diameter Wheels

Size		Grit	Face Width	Trim Length	Max RPM	Part No.	Qty Per Box
Dia.	Arbor						
3	5/8	80	1/2	5/8	18,000	04110	1
3	5/8	320	1/2	5/8	18,000	04120	1
4	5/8	120	5/8	3/4	12,000	04130	1
4	5/8	180	5/8	3/4	12,000	04140	1
6	2	120	7/8	1-1/16	6,000	04150	1

Small Diameter Wheels

Size		Grit	Face Width	Trim Length	Max RPM	Part No.	Qty Per Box
Dia.	Arbor						
1-1/2	1/2	320	1/4	1/4	20,000	04210	4
2-1/2	5/8	120	3/8	11/16	15,000	04230	4
2-1/2	5/8	320	3/8	11/16	15,000	04240	4

Tube Brushes

Dia.	Grit	Trim Length	Overall Length	Part No.	Qty Per Box
1/2	80	2	5	04270	12
1	80	2-1/2	5-1/2	04275	12
1-1/4	80	2-1/2	5-1/2	04280	12
5/8	120	2	5	04285	12
1	120	2-1/2	5-1/2	04290	12

Cup Brushes

Size		Grit	Trim Length	Max RPM	Part No.	Qty Per Box
Dia.	Arbor					
4	5/8-11	80	1-1/2	6,000	04310	1
6	5/8-11	80	1-1/2	6,000	04340	1

End Brushes

Dia.	Grit	Trim Length	Overall Length	Max RPM	Part No.	Qty Per Box
1	120	1	2-3/4	19,000	04380	12
1	80	1	2-3/4	9,000	04390	6



WIRE BRUSHES

BRUSHES



Die Grinder

BURS

Tungsten Carbide Burs

United Abrasives offers a complete line of tungsten carbide burs in the most popular shapes and sizes to meet your needs. Choosing the right bur depends on the material to be ground, grinding speed, desired shape and finish requirements. United Abrasives' burs are precision ground with diamond wheels resulting in a concentric tool with very sharp, uniform teeth. This manufacturing method produces the highest quality bur, properly balanced for vibration-free operation and long tool life. Tungsten burs are best suited for efficient material removal at high RPMs. United Abrasives' burs are made in the U.S.A.

Double Cut (Alternate Cut)



Double cut or alternate cut is the most popular bur in ferrous applications. Manufactured with cuts made on the left and right spirals, this design produces a finer finish on material producing smaller chips and slivers. The double cut offers much smoother operation and greater tool control.

Non-Ferrous (Aluminum Cut)



Non-ferrous or aluminum cut burs have a more open, aggressive cut to avoid loading on softer materials. This design provides outstanding stock removal on aluminum, magnesium, copper, soft steel, brass, zinc alloys, hard rubber, most plastics, and non-ferrous metals. These burs provide easy chip flow with little or no clogging.



Features

- Tungsten Carbide construction for long life and precision cutting
- Highest quality construction for proper balance which delivers vibration-free operation
- Double cut provides smooth operation and maximum tool control
- Non-ferrous burs have an open design for non-loading on softer materials

Applications

- Excellent for confined or hard-to-reach areas
- Use for deburring and finishing on ferrous and non-ferrous metals
- Shaping and enlarging holes in steel
- Removing welds
- Smoothing castings

MAXIMUM RECOMMENDED RPMs FOR CARBIDE BURS

FILE DIA.	RPM(1)	RPM(2)
1/4"	22,000	33,000
5/16"	20,000	30,000
3/8"	18,000	27,000
1/2"	16,000	24,000

Use RPM(1) for iron, steel welds, cast iron, tool steels, die steels, bronze, brass and aluminum.

Use RPM(2) for stainless steel.

BURS

Tungsten Carbide Burs



Die Grinder

SB
(End Cut)



SH

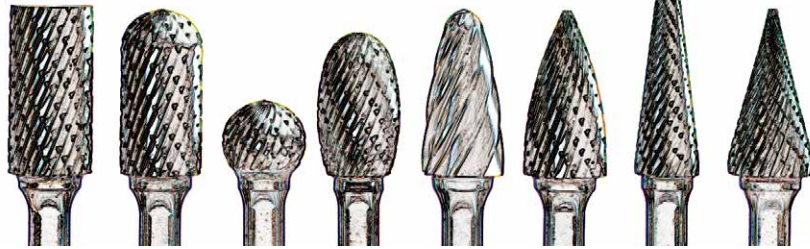

SA SC SD SE SF SG SL SM



Wooden Display Case
Holds up to 8 burs
P/N 99046

Heavy Duty

Type	Burr Size		Shank Dia.	Part Numbers	Qty/Box
	Dia.	Length			
SA5	1/2	1	1/4	45125	1
SC5	1/2	1	1/4	45130	1
SE5	1/2	7/8	1/4	45135	1
SF3	3/8	3/4	1/4	45140	1
SF5	1/2	1	1/4	45145	1
SG5	1/2	1	1/4	45150	1
SL3	3/8	1-1/16	1/4	45155	1
SL4	1/2	1-1/4	1/4	45160	1

6" Length Shank

Type	Burr Size		Shank Dia.	Part Numbers	Qty/Box
	Dia.	Length			
SA3L6	3/8	3/4	1/4 6L	45603	1
SA5L6	1/2	1	6L	45605	1
SB1L6	1/4	5/8	6L	45611	1
SB3L6	3/8	3/4	6L	45613	1
SC3L6	3/8	3/4	6L	45623	1
SD1L6	1/4	7/32	6L	45631	1
SD3L6	3/8	5/16	6L	45633	1
SE5L6	1/2	7/8	6L	45645	1
SF3L6	3/8	3/4	6L	45653	1
SF5L6	1/2	1	6L	45655	1
SG3L6	3/8	3/4	6L	45663	1
SG5L6	1/2	1	6L	45665	1
SH2L6	5/16	3/4	6L	45672	1
SL3L6	3/8	1-1/16	6L	45683	1
SM3L6	1/4	1	6L	45693	1
SC3NFL6	3/8	3/4	6L	45063	1
SF3NFL6	3/8	3/4	6L	45073	1
SD3NFL6	3/8	5/16	6L	45083	1

Type	Burr Size		Shank Dia.	Part Numbers	Qty Per Box
	Dia.	Length			
SA1	1/4	5/8	1/4	45000	1
SA3	3/8	3/4	1/4	45001	1
SA5	1/2	1	1/4	45002	1
SB1	1/4	5/8	1/4	45111	1
SB3	3/8	3/4	1/4	45004	1
SB5	1/2	1	1/4	45113	1
SC1	1/4	5/8	1/4	45005	1
SC3	3/8	3/4	1/4	45006	1
SC5	1/2	1	1/4	45007	1
SD1	1/4	7/32	1/4	45010	1
SD3	3/8	5/16	1/4	45011	1
SD5	1/2	7/16	1/4	45012	1
SE1	1/4	3/8	1/4	45015	1
SE5	1/2	7/8	1/4	45016	1
SF1	1/4	5/8	1/4	45020	1
SF3	3/8	3/4	1/4	45021	1
SF5	1/2	1	1/4	45022	1
SH1	1/4	5/8	1/4	45115	1
SH2	5/16	3/4	1/4	45116	1
SH5	1/2	1-1/4	1/4	45117	1
SL1	1/4	5/8	1/4	45025	1
SL3	3/8	1-1/16	1/4	45026	1
SL4	1/2	1-1/4	1/4	45027	1
SG1	1/4	5/8	1/4	45030	1
SG3	3/8	3/4	1/4	45031	1
SG5	1/2	1	1/4	45032	1
SM1	1/4	1/2	1/4	45035	1
SM2	1/4	3/4	1/4	45036	1
SM4	3/8	3/4	1/4	45037	1
SM5	1/2	1	1/4	45038	1

Double Cut (Alternate Cut)

Non-ferrous (Aluminum)

SA3NF	3/8	3/4	1/4	45050	1
SA5NF	1/2	1	1/4	45051	1
SC3NF	3/8	3/4	1/4	45052	1
SF3NF	3/8	3/4	1/4	45053	1
SF5NF	1/2	1	1/4	45054	1
SL4NF	1/2	1-1/8	1/4	45055	1



- Tungsten carbide construction for long life and durability
- High quality manufacturing method delivers vibration-free operation
- Precision ground with diamond wheels to produce a very sharp uniform cutting edge
- Each enclosed in individual plastic capsules for storage and protection

CARBIDE
BURS

BURS

Accessories

Backing Pads for Resin Fiber Discs



- Spiralcool™ backing pads' exclusive rubber, fabric, and fiber board construction provide extra strength and reliability
- Spiral ribs provide contact points and form channels for air flow extending disc life 30% to 50%
- Each pad is supplied with a nut as indicated

NOTES: Additional nuts may be purchased separately. This backing pad is not to be used with SAIT-LOK™ quick change fiber discs

Size	Arbor	Grade Available			Max RPM
		Soft	Med	Hard	
4	5/8-11 Thread	-	95010	-	12,000
4-1/2	5/8	-	95011	-	11,000
4-1/2	1/2	-	95012	-	11,000
5	5/8	-	95016	-	10,000
7	5/8-11 Thread	95017	-	-	7,000
7	5/8-11 Thread	-	95018	95019	8,500
9	5/8-11 Thread	-	95021	95022	6,500

Spanner Wrench



- Adjustable wrench for tightening and loosening center nuts
- Fits all center nuts

Description	Part No
Spanner Wrench	95008

SAIT-LOK™ Backing Pads for Resin Fiber Discs



- Smooth face backing pad for SAIT-LOK™ fiber disc
- Minimizes change-over downtime
- No additional mounting hardware required
- Each pad is supplied with nut and washers

NOTE: SAIT-LOK™ disc must be used with threaded backing pad

Size	Part No	Max RPM
*4-1/2 x 5/8-11	95023	18,000
4-1/2 x 5/8-11	95025	18,000
*5 x 5/8-11	95024	18,000
5 x 5/8-11	95026	18,000
7 x 5/8-11	95027	8,600
9 x 5/8-11	95028	6,600

* Low profile for short spindles

Challenger II™ Backing Pad



- For use with Challenger II flexible grinding/blending wheels (pg. 21)
- Set includes 5/8-11 nut and pad

Description	Part No	Max RPM
Pad for 4-1/2 & 5" Challenger II™	95245	13,300/12,200
Pad for 7" Challenger II™	95247	8,500

Accessories

Center Nuts



- For attaching fiber discs to backing pad and tool
- Use small* for 4", 4-1/2", 5" diameter pads
- Use large* for 7", 9" diameter pads

Size	Part No
5/8-11 Small*	95040
5/8-11 Large*	95041
1/2-13	95042
M10 x 1.25	95043

Type 1 (41) Cut-Off Adaptors



- For use with Type 1 Thin High Speed Cut-Off wheels up to 3" diameter only (pg. 46)

Size	Part No
1/4 x 1/4-20	95002
1/4 x 3/8-24	95003

Type 27 Reusable Adaptor Kit



- For use with Type 27 wheels on 7" and 9" 5/8-11 spindle grinders
- Alternative to a throwaway hub

Description	Part No
Reusable Adaptor Kit	95000

Type 1 (41) & Type 27 (42) Reusable 5/8-11 Adaptor



- Reusable 5/8-11 adaptor for use on Type 1 and Type 27 reinforced wheels with a 7/8 arbor, a max. diameter of 5" and a wheel thickness of .045 to 1/8"

Description	Part No
5/8-11 Reusable Adaptor	95055

Type 1 Cut-Off Wheel Reducing Bushings



- For use with Type 1 Cut-Off wheels
- Reduces wheel arbor size

Size	Part No	Size	Part No
1-5/8	95030	7/8-5/8	95034
1-20mm	95031	Dia. -5/8	95035
1-7/8	95032	Dia. -1/2	95036
1-3/4	95033	1/2-3/8	95037

Accessories

PSA Backing Pads



- For use with PSA adhesive backed sanding discs (pg. 89-92, 95-97)
- 1/4" Shank pads for die grinders
- Threaded pads for dual action/random orbital sanders and right angle grinders/sanders



Portable Grinder

Size	Part No	Max RPM
1 x 1/4	95059	30,000
1-1/2 x 1/4	95060	30,000
2 x 1/4	95061	28,000
3 x 1/4	95062	20,000
4 x 1/4	95063	16,000
5 x 1/4	95064	12,000



Disc Sander

Size	Part No	Max RPM
5 x 5/16-24	95065	10,000
5 x 5/16-24 5 holes	95085	10,000
6 x 5/16-24	95066	10,000
6 x 5/16-24 6 holes	95086	10,000
8" w/mounting holes	95180	1,500

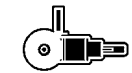

Angle Grinder

Size	Part No	Max RPM
7 x 5/8-11	95068	4,800
8 x 5/8-11	95067	4,800

Hook & Loop Backing Pads for Paper Discs



- For use with Hook & Loop backed paper discs (pg. 93-95)
- Available in 5/16-24 thread

Description	Part No	Max RPM
5 x 5/16-24	95047	10,000
5 x 5/16-24 5 holes	95057	10,000
5 x 5/16-24 8 holes	95058	10,000
6 x 5/16-24	95046	10,000
6 x 5/16-24 6 holes	95056	10,000
8" w/ 5 mounting holes	95185	1,500
8 x 5/8-11	95187	1,500

Palm Hand Sander



- For manual use with PSA (pp. 89-92, 95-97) or Sand-Light™ / Hook & Loop discs (pg. 122)
- For more uniform finish when hand sanding

Size	PSA	Sand-Light™
5"	95091	95081
6"	95092	95082

Contour Hand Pads



- For manual use with PSA or Hook & Loop discs (pg. 89-97)
- For more uniform finish when hand sanding

Size	PSA	Hook & Loop
6"	95260	95250

Hook & Loop Soft Interface Pads



- For use with 5" and 6" Hook & Loop Backing Pads
- Excellent for final finishing as the soft foam backing makes the grain cut less and finish finer
- The perfect compliment for the 4S/4V Hook & Loop products (pg. 94)

Description	Part No
5" Soft Interface Hook & Loop Pad	95175
6" Soft Interface Hook & Loop Pad	95176

Accessories

Sand-Light™ Surface Conditioning Backing Pads



- For use with Hook & Loop style Sand-Light™ Discs (pg. 122)
- 1/4" shank pads
- Threaded pads for dual action random orbital sanders
- Threaded pads for right angle grinders/sanders



Portable Grinder

Size	Part No	Max RPM
4 x 1/4	95154	15,000
5 x 1/4	95153	10,000



Disc Sander

Size	Part No	Max RPM
4 x 5/16-24	95157	10,000
5 x 5/16-24	95155	10,000
6 x 5/16-24	95156	10,000



Angle Grinder

Size	Part No	Max RPM
4-1/2 x 5/8-11	95159	6,000
5 x 5/8-11	95160	6,000
6 x 5/8-11	95161	6,000
7 x 5/8-11	95162	4,800
8 x 5/8-11	95163	4,800

Sand-Light™ Handle



- For manual use with Sand-Light™ 6 x 9 hand pads (pg. 119)
- For more uniform finish when hand sanding

Description	Part No
Sand-Light™ Handle	95080

SAIT-LOK™ Backing Pads for Laminated & Surface Conditioning Discs



- For use with SAIT-LOK™ laminated (pg. 98-100) and surface conditioning discs (pg. 121)
- Disc twists into metal threaded center of backing pad for fast and easy disc changes
- Now available in hard density for aggressive cutting action
- 1/4" shank

Size	Part No	Max RPM	Size	Part No	Max RPM
1" Medium	95165	40,000	1-1/2" Hard	95266	30,000
1-1/2" Medium	95166	25,000	2" Hard	95267	30,000
2" Medium	95167	25,000	3" Hard	95268*	20,000
3" Medium	95168	20,000			

SAIT-LOK-R™ Backing Pads for Laminated, Surface Conditioning, & Cotton Fiber Discs

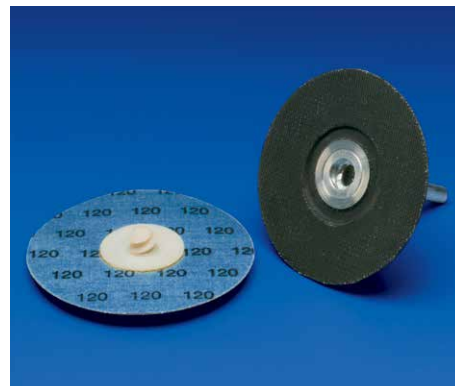

- For use with SAIT-LOK-R™ laminated (pg. 98-100), surface conditioning discs (pg. 121), Cotton fiber discs (pg. 31), Encore Mini Flap Discs (pg. 98)
- Nylon threaded hub of disc twists into backing pad for secure fit
- Now available in hard density for aggressive cutting action
- Minimizes change-over time
- 1/4" shank

Size	Part No	Max RPM	Size	Part No	Max RPM
1-1/2" Medium	95171	25,000	1-1/2" Hard	95271	30,000
2" Medium	95172	25,000	2" Hard	95272	30,000
3" Medium	95173	20,000	3" Hard	95273	20,000
4" Medium	95280	12,000			

ACCESSORIES

Accessories

Wood Wedges



- For use with Vitrified Bonded Floor Rubs (pg. 32)
- Skin packaged in quantities of 2 per package

Description	Part No
Wood Wedges	95100

Abrasive Cleaning Stick



- For removing loaded material from sanding belts
- Increases abrasive life
- 100% natural rubber; environmentally safe
- Lasts twice as long as conventional (crepe) belt cleaners and will not cause gummy residue
- Size: 1-5/8" x 1-5/8" x 8"

Description	Part No
Abrasive Cleaning Stick	95083

SAIT-PAK™ Accessories



- For use with SAIT-PAK™ 9" x 11" Sheets (pg. 105)

Description	Part No
Hand Sanding Block	16000

1/4" Shank Threaded Adaptor for Flap Wheels



- For use on United Abrasives 1/4-20 threaded flap wheels
- Facilitates a quick change, thus less downtime

Description	Part No
1/4" Threaded Adaptor	95050

1/4" Shank Adaptor Kit for Flap Wheels



- For converting 1" or 5/8" arbors to a 1/4" shank
- 1/4" Shank adaptor kit

Description	Part No
Adaptor Kit	95009

Cartridge Roll Mandrels



- For use with straight and full taper cartridge rolls on pages 112-113

Size	Part No
1/4 x 1-1/2 x 1/4	95101
1/4 x 1 x 1/4	95102
1/8 x 1-1/2 x 1/4	95103
1/8 x 1 x 1/4	95104
1/8 x 3/4 x 1/4	95105
3/16 x 1-1/2 x 1/4	95106
3/16 x 1 x 1/4	95107
3/32 x 3/4 x 1/8	95108

Spiral Band Drums



- For use with spiral bands on page 111

Size	Max RPM	Part No
1/2 x 1/2 x 1/4	30,000	95121
1/2 x 1 x 1/4	15,000	95122
1/2 x 1-1/2 x 1/4	12,000	95123
3/4 x 1 x 1/4	19,000	95126
3/4 x 1-1/2 x 1/4	10,000	95127
1 x 1 x 1/4	18,000	95130
1-1/2 x 1 x 1/4	14,000	95133
1-1/2 x 1-1/2 x 1/4	10,000	95134
2 x 2 x 1/4	6,000	95137
3 x 3 x 1/4	3,000	95140

Cross Pad & Square Pad Mandrels



- For use with cross and square pads on page 114
- 1/4" shank

Size	Part No
3-48	95095
8-32	95096
1/4-20	95097

Accessories

Super Soft Buffing Disc Backing Pads



- For use with buffing discs (pg. 130)
- Available in 5" & 7" with 5/8-11 thread

Description	Max RPM	Part No
5" Super Soft Foam Pad	3,200	95255
7" Super Soft Foam Pad	3,200	95257

Buffing Disc Compounds and Kits

Brown Bar: Used for buffing aluminum, brass, copper, wood, plastics, hard rubber, and painted surfaces. Also called tripoli rouge.

White Bar: Used for buffing stainless steel, carbon steel, nickel, aluminum, and chromium to a high luster shine.

Red Bar: For buffing precious metals like gold, silver, platinum, sterling, and other high end metals. Can also be used to further enhance materials that have already been buffed with other compounds. The finest grade.

Black Bar: Used to buff contaminants out prior to finishing. Will remove rust, stains, scale, and other contaminants. An extremely fast cutting material. Also called emery cake.



Description	Part No
Buffing Compound Kit	41000
1 lb Buffing Compound Bar Brown	41024
1 lb Buffing Compound Bar White	41022
1 lb Buffing Compound Bar Red	41020
1 lb Buffing Compound Bar Black	41026

Convolute Wheel and Non-Woven Flap Brush Reducing Bushings



- Re-usable reducing bushings for use with Convolute Wheels and Flap Brushes
- Packaged per pair

Description	Part No	For Use With:
1" OD to 3/8" ID	95210	6" Diameter Convolute Wheels
1" OD to 3/4" ID	95216	6" Diameter Convolute Wheels
3" OD to 1-1/4" ID	95232	8" Diameter Convolute Wheels and Non-woven Flap Brushes

PROMOTIONAL LITERATURE



.045 Cut-Off Wheels
Part #99045



Flap Discs
Part #99984



The Ultimate Combo™
Part #99983



MRO
(Maintenance, Repair & Operations)
Part #99048

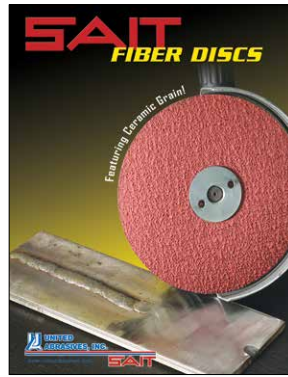

Fiber Discs
Part #99028

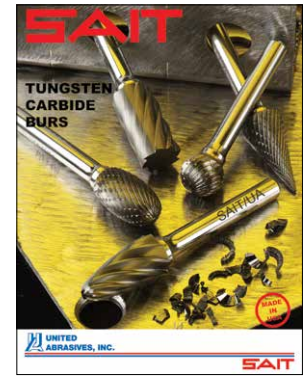

Carbide Burs
Part #99220

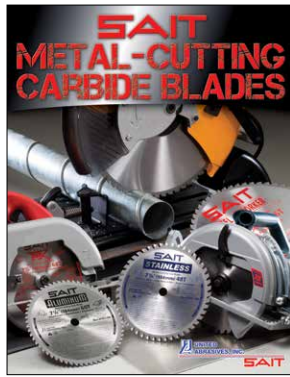

Metal-Cutting Carbide Blades
Part #99982

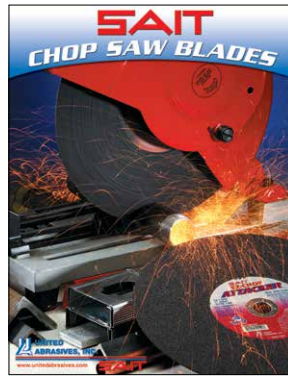

Chop Saw Wheels
Part #99014

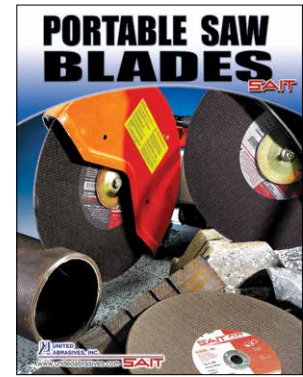

Portable Saw Blades
Part #99040

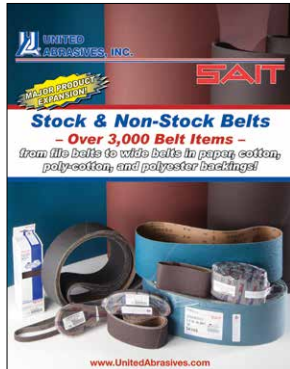

Stock & Non-Stock Belts
Part #99991

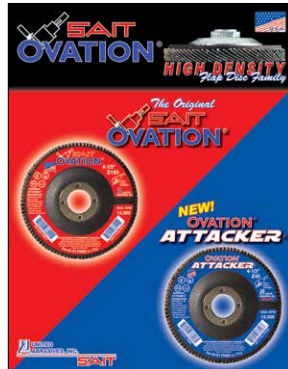

Ovation® Family
Part #99980
will be phased out once depleted



Company Overview
Part #99981

POINT OF PURCHASE (P.O.P.) DISPLAY

99084 – Red Pegboard Display Panel

- Also included in the box are
4 tan hangers / spacers

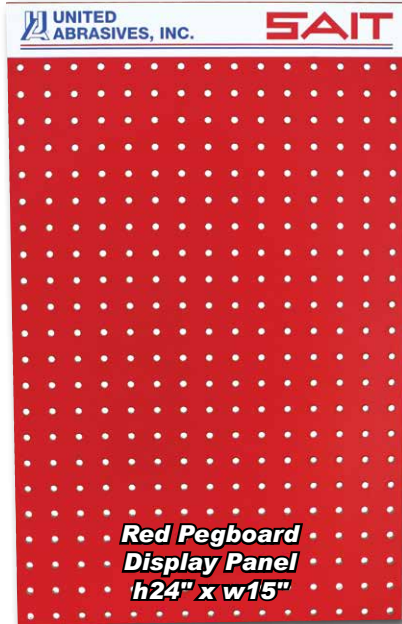

99157 – Plastic Display Tag Holders (1 Package)



4 – 3" tags to use with Material Labels

2 – 4" tags to use with Application Labels

* The 4" tags have an insert that slides into the track on the back in order to be hung on the pegboard display.

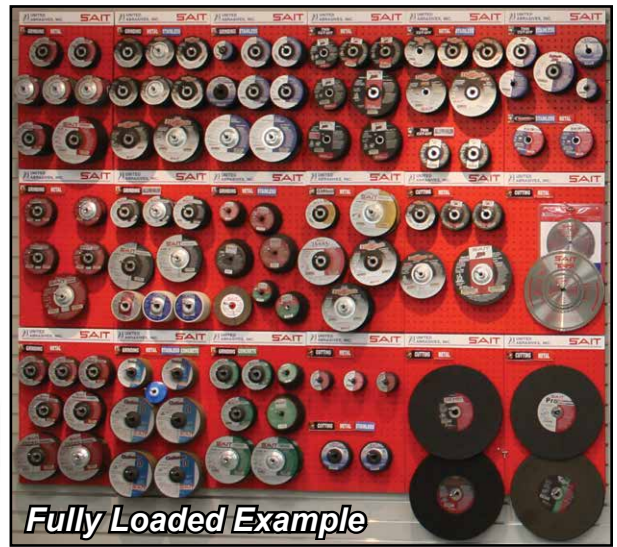

Fully Loaded Example



99156 – 6" Pegboard Hooks (8 Pack)



Tan Hangers/Spacers

* 2 of the Hangers/Spacers are to be inserted into the current pegboard or slatwall behind and near the bottom of the new red pegboard display panel to keep it parallel with the wall.



99094 – Material Display Tag Labels (1 Sheet)



99095 Application Display Tag Labels (1 Sheet)

Order Reference for 1 Complete Red Pegboard Setup		
Part No.	Qty.	Order
99084.....	1.....	_____
99157.....	1.....	_____
99156.....	1.....	_____
99094.....	1.....	_____
99095.....	1.....	_____

MISCELLANEOUS PARTS



97037 – Wire Basket Qty. _____



97036 – 14" Wire Wheel Holder Qty. _____



97039 – POP Label Card Qty. _____ 1 per wheel holder & wire basket

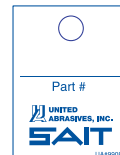

99080 – Reorder Hang Tag Qty. _____ Order in multiples of 50

POP DISPLAY

150

P.O.P. DISPLAY

COUNTER RACK DISPLAY UNIT

99079 – Counter Display Rack

Qty. _____
h17" x w15.5" x d11"

99115 – 4" Hooks (6 pack)

Qty. _____
Hooks do not
come with racks



99088 – 4 Wheel
Counter Display Rack

Qty. _____
h17" x w15.5" x d11"



StackPack



Packaged 2 per box

- 25 wheels per Stack Pack
- Sturdy plastic case for stacking on counter in a small footprint
- Barcoded as a 25 pack for scanning

17100

- Contains 25 - 4½ x .045 x 7/8 Type 1 A60S (23101)

17105

- Contains 25 - 5 x .045 x 7/8 Type 1 A60S (23103)

LARGE PRINTED ADVERTISING



97018 – Header and Holder

Qty. _____ (ships with 99160)
Approximately h12" x w36"

Footers clip onto top of display backer
and are used to support the header

Rectangle Header Cards - 1 per counter rack
(Used ONLY for Counter Racks)

Part#	Description	Qty.
99098	United Abrasives/SAIT Header.....	_____
99104	Concrete cutting.....	_____
99106	Flap discs.....	_____
99107	Metal cutting.....	_____
99108	Metal grinding.....	_____
99109	Metal grinding/blending.....	_____
99110	Stainless Steel cutting.....	_____
99111	Stainless Steel grinding.....	_____
99112	Wire Brushes.....	_____
99113	Accessories.....	_____
99114	Aluminum.....	_____
99117	Metal/Stainless Steel cutting.....	_____
99118	Metal/Stainless Steel grinding.....	_____
99123	Belts.....	_____
99155	US Flap Disc.....	_____
99158	.045" Family.....	_____

99155



99158



99043 – Banner

Qty. _____
h2' x w4' with grommets

POP DISPLAY

Contact your Sales Representative for more information on how to order.

www.UnitedAbrasives.com

Safety Guide

Important:

The following information about safety should be used only as a guide. All products listed in this catalog shall be used in accordance with safety regulations set by OSHA and by the directive described by the American National Safety Institute B7.1, the Canadian Standard Association Safety Code B-173-5 and by the American Brush Manufacturers Association covering: Speed, Safety Guards, Flanges, Mounting Procedures, General Operating Rules, Handling, Storage, and Inspection of General Machine Conditions.

The information to the right is designed as a guide for the individual user of abrasive wheels, whether he be in the employ of a large corporation or in the confines of his home work shop. It is based on the premise that grinding/cutting is a safe operation when a few basic rules are followed. These rules are based on material contained in the American National Standards Institute Safety Requirements B7.1 - "Use, Care & Protection of Abrasive Wheels." Follow Them.



Warning:

Avoid inhalation of dust generated by grinding and cutting operations. Exposure to dust may cause respiratory ailments as well as irritation to eyes and skin. In most cases, a greater hazard is the exposure to the dust/fumes from the base material being ground or paint or coatings applied to it. Use approved NIOSH or MSHA respirators, safety glasses or face shields, gloves and protective clothing. Provide adequate ventilation to eliminate dust or to maintain dust levels below the permissible exposure level for nuisance dust as classified by OSHA. Refer to Material Safety Data Sheet for further information.

All operators must read and understand safety information thoroughly.

Follow Safety Instructions:

You must follow all operator and safety instructions, as well as all common safety practices which reduce the likelihood of physical injury.

Operate Wheels at Recommended Speeds:









It is imperative that abrasive wheels be operated at recommended safe speeds. For safety reasons no abrasive wheel shall be operated at a speed greater than that indicated on the blotter or wheel.

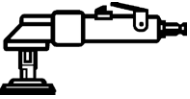





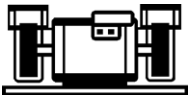

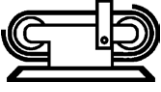

- Do always handle and store wheels in a careful manner.
- Do visually inspect all wheels before mounting for possible damage.
- Do make sure operating speed of machine does not exceed speed marked on wheel, its blotter or container.
- Do check mounting flanges for equal size, relieved as required & correct diameter.
- Do use mounting blotters as required by ANSI standards.
- Do be sure work rest is properly adjusted on bench, pedestal and floor stand grinders.
- Do always use safety guard that covers a minimum of one-half (1/2) the abrasive wheel.
- Do allow newly mounted wheels to run at operating speed, with guard in place, for at least one minute before grinding.
- Do always wear safety glasses or some type of approved eye protection while grinding or cutting.
- Do turn off coolant before stopping wheel to avoid creating an out-of-balance condition.
- Do follow common sense safety considerations.
- Do follow federal, state and local laws and regulations.
- Don't use a wheel that has been dropped or appears to have been abused.
- Don't force a wheel onto the machine or alter the size of the mounting hole. If wheel won't fit the machine, get one that will.
- Don't ever exceed maximum operating speed established for the wheel.
- Don't use mounting flanges on which the bearing surfaces are not clean, flat and smooth.
- Don't tighten the mounting nut excessively.
- Don't grind on the side of conventional, straight or Type 1 wheels.
- Don't use a wheel on any machine that is not properly designed for the specific application of the wheel.
- Don't start the machine until the safety guard is properly and securely in place.
- Don't jam work into the wheel.
- Don't stand directly in front of a grinding/cutting wheel whenever a machine is in operation.
- Don't grind or cut material for which the wheel is not designed.

A pamphlet including these Do's and Don'ts and other safety information is included in each box of wheels.

Products By Tool Index

The tool graphic found on each page of the catalog represents the appropriate tool the product can be used on. These icons are also located on our product and box labels for easy identification.

Tool Icon	Page #
	14-23, 28-30, 36-45, 48, 62-62, 70-76, 78-82, 102, 122, 126-127, 129-130, 133-136, 139
	31, 76, 98-100, 121-123, 129-130
	24-25, 30-31, 46, 101, 111-114, 125, 127, 129, 137, 139-141
	41, 48, 60-63
	50-51
	56-57
	52-54
	55, 137
	33, 102, 123-124, 128-129, 133, 139
	86-87, 120
	60-61

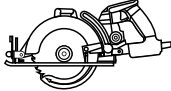
Tool Icon	Page #
	86-87, 120
	86-87, 120
	115-117
	89-95
	96-97, 122-123, 130
	116
	107
	106
	86-87, 120
	60-61
	60-61



The



SAIT

Difference



When Quality, Service, and Dependability Count!



WORLDWIDE LEADERS IN THE ABRASIVES MARKET

- **U.S. Manufacturing**

185 Boston Post Road
North Windham, CT 06256
860.456.7131 • 800.428.5927

3551 Westview Drive
Naples, FL 34104

- **Sait Abrasivi S.p.A.**

Via Torino Pianezza, 20
10093 Collegno (TO), Italy

- **Sait Abrasives (UK) Ltd.**

Regent House, Meridian East
Meridian Business Park
Leicester, LE19 1WZ, England (UK)

- **Sait France E.u.r.l.**

18, rue Ampère – ZI – B.P. 40020
95001 Gonesse Cedex, France

- **Sait Abrasivos LTDA**

Avenida São Gabriel 433
83404-000 – Colombo – Paraná, Brasil

- **Abrasivos Sait España S.A.**

Via Europa, 10, P.I. Pla de Llerona
08520 Les Franqueses del Valles (BCN), España

- **Salt Lake City Distribution Center**

837 West 2600 South
Salt Lake City, UT 84119

- **Canada Distribution Center**

1835 Meyerside Drive, Unit 3
Mississauga, ON L5T 1G4



PRODUCT WARRANTY

United Abrasives, Inc. warrants that all industrial products it manufactures will be as represented in its catalog and will be free from defects in material and workmanship under normal use for which the product was intended if, but only if, it has been properly stored and used. Our obligation under this Warranty shall be limited to either the exchange of any product proven to be defective under normal use or to refund the purchase price thereof, at our option, within six months from the date of purchase by the original purchaser. The term "original purchaser", as used in this Warranty, shall be deemed to mean that person or company to whom the product was originally sold. This remedy is purchaser's exclusive remedy against United Abrasives, Inc. for any damages to either person or property caused by any defect or other failure in the product. Said refund or exchange shall constitute a fulfillment of any and all liabilities of United Abrasives, Inc. with respect to the quality of the product sold by it.

THIS WARRANTY IS EXPRESSLY IN LIEU OF ALL OTHER WARRANTIES EXPRESSED OR IMPLIED, INCLUDING THE WARRANTIES OF MERCHANTABILITY AND FITNESS FOR USE AND OF ALL OTHER OBLIGATIONS OR LIABILITIES ON OUR PART, AND WE NEITHER ASSUME NOR AUTHORIZE ANY OTHER PERSON TO ASSUME FOR US, ANY OTHER LIABILITY IN CONNECTION WITH THE SALE OF OUR PRODUCTS. THIS WARRANTY SHALL NOT APPLY TO ANY PRODUCT SOLD BY US WHICH HAS BEEN SUBJECT TO ACCIDENT, NEGLIGENCE, ALTERATION, ABUSE, OR MISUSE. WE MAKE NO WARRANTY WITH RESPECT TO ACCESSORIES OR PARTS EMPLOYED BY THE USER WITH OUR PRODUCT WHICH WERE NOT SUPPLIED BY UNITED ABRASIVES, INC. UNDER NO CIRCUMSTANCES IS UNITED ABRASIVES, INC. LIABLE FOR ANY DIRECT INCIDENTAL, SPECIAL, OR CONSEQUENTIAL DAMAGES (INCLUDING LOST PROFITS) IN ANY WAY RELATING TO THE PRODUCTS SOLD BY UNITED ABRASIVES, INC.

All products listed in this catalog must be used in accordance with the safety regulations set by **OSHA**, by the directive described by the **American National Safety Institute B7.1** ("Safety Requirements for the Use, Care and Protection of Abrasive Wheels") and by the **American Brush Manufacturers Association**. The user of any United Abrasives, Inc. product should be thoroughly familiar with the above safety rules and regulations before use of the product.

Bonded & Coated Abrasives from the Service Leader!



NG WHEELS • .045" THIN CUT-OFF • CHOP SAW WHEELS
SAIT WHEELS • .045" THIN CUT-OFF • CHOP SAW WHEELS
ETS • SHOP ROLLS • WIRE BRUSHES • NON-WOVEN
L-CUTTING CARBIDE BLADES • GRINDING WHEELS
THIN CUT-OFF • CHOP SAW WHEELS • GAS SAW WHEELS
LTS • FIBER DISCS • FLAP DISCS • SHEETS • SHOP ROLLS
RE BRUSHES • NON-WOVEN • METAL-CUTTING CARBIDE
ADES • GRINDING WHEELS • .045" THIN CUT-OFF • CHOP SAW WHEELS
GAS SAW WHEELS • BELTS • FIBER DISCS • FIBER DISCS • FIBER DISCS
R ROLLS • WIRE BRUSHES • NON-WOVEN
ADES • GRINDING WHEELS • GRINDING WHEELS • GRINDING WHEELS

 **UNITED
ABRASIVES, INC.**